

Zajednica izvršitelja



Naručitelj



Krajnji korisnik



STUDIJA OCJENE I PRAĆENJA UČINKOVITOSTI PROVEDBE PROJEKTA
IZGRADNJE KANALIZACIJSKE MREŽE I ANALIZA UČINKOVITOSTI RADA UREĐAJA
ZA PROČIŠĆAVANJE OTPADNIH VODA U GRADU POREČU – STUDIJA POREČ

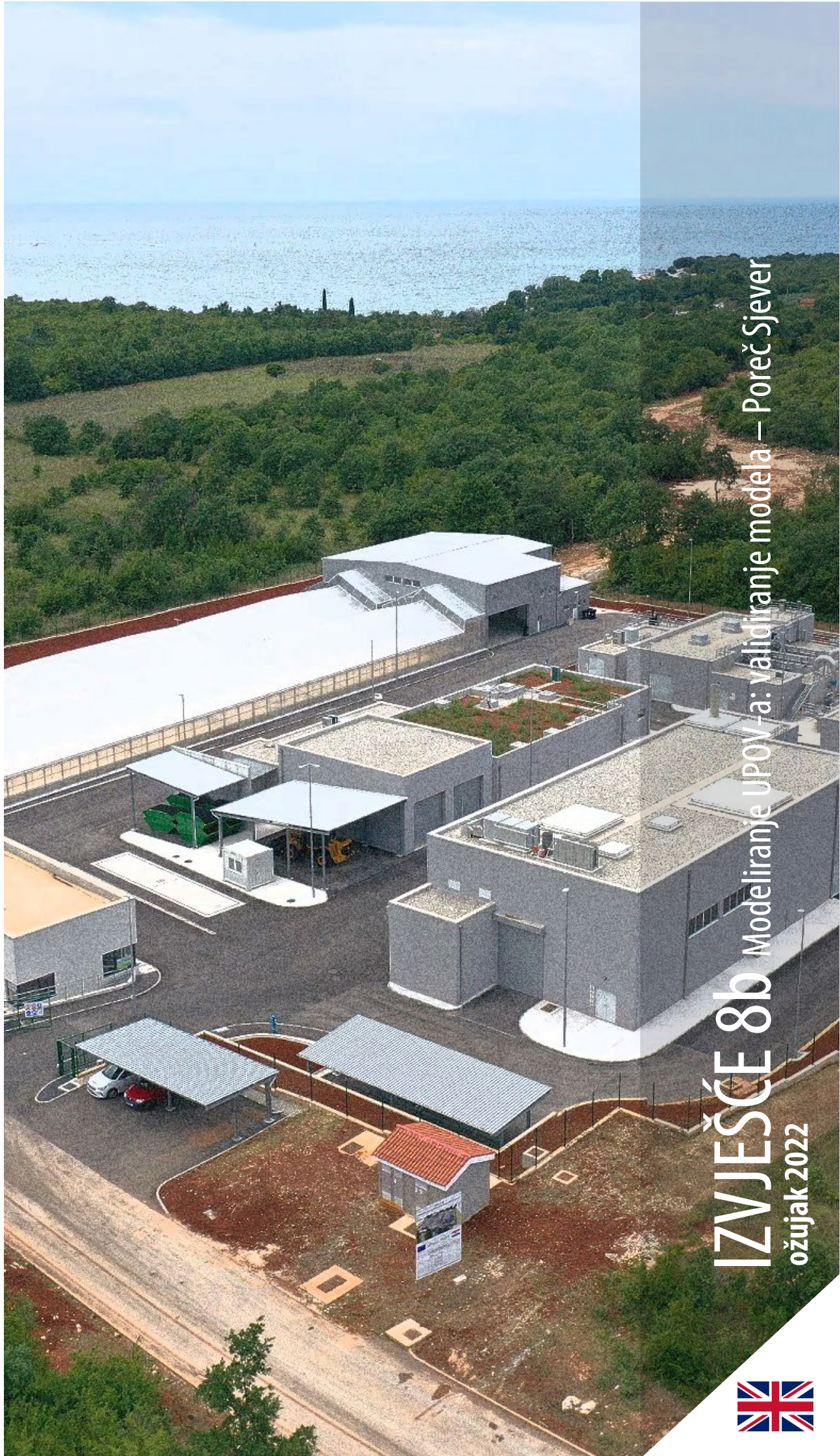

IZVJEŠĆE 8b Modeliranje UPOV-a: validiranje modela – Poreč Sjever
ožujak 2022



STUDIJA OCJENE I PRAĆENJA UČINKOVITOSTI PROVEDBE PROJEKTA IZGRADNJE
KANALIZACIJSKE MREŽE I ANALIZA UČINKOVITOSTI RADA UREĐAJA ZA
PROČIŠĆAVANJE OTPADNIH VODA U GRADU POREČU – **STUDIJA POREČ**

IZVJEŠĆE 8 – dio 2/4

Modeliranje UPOV-a: validiranje modela

Ožujak 2022

Zajednica izvršitelja



Naručitelj



Krajnji korisnik



STUDIJA OCJENE I PRAĆENJA UČINKOVITOSTI PROVEDBE PROJEKTA IZGRADNJE
KANALIZACIJSKE MREŽE I ANALIZA UČINKOVITOSTI RADA UREĐAJA ZA
PROČIŠĆAVANJE OTPADNIH VODA U GRADU POREČU – **STUDIJA POREČ**

IZVJEŠĆE 8 – dio 2/4

Modeliranje UPOV-a: validiranje modela

5. ožujka 2022

mr.sc. Božidar Deduš, dipl. ing.
Ovlaštenik Zajednice izvršitelja
Proning DHI d.o.o.

5. ožujka 2022

United Nations
Institute for Water Education
IHE
DELFT
under the auspices
of UNESCO

prof. dr. sc. Damir Brdjanovic, dipl. ing.
Voditelj stručnog tima
IHE Delft

Evaluation and efficiency monitoring of the new implemented sewage network and wastewater treatment construction in the larger city of Poreč.

Report 8.2 – Wastewater treatment model calibration and validation.

WWTP Poreč-North

2022 02 28

Definitive Concept



Lagen-Aarleseweg 13
 NL – 5425 PD De Mortel (NB)
 The Netherlands

Phone: + 31 (0) 6 24842234

Mail: meijer@asmdesign.nl

Web: www.asmdesign.nl

IBAN: NL66 RABO 0113 1888 46

SWIFT: RABONL2U

VAT: NL-175272530B01

Business registration: 30206848

Responsibility

| | |
|-----------------------|---|
| Project Title | : Evaluation and efficiency monitoring of the new implemented sewage network and wastewater treatment construction in the larger city of Poreč. |
| Working Title | : Report 8.2 – Wastewater treatment model calibration and validation WWTP Poreč-North. |
| Project Description: | : Study of the environmental impact as the result of upgrading and operation of the wastewater system of the larger city of Poreč on coastal sea water quality. Integrated evaluation of the sewer system, wastewater treatment systems, coastal discharge, and sea water quality based on modelling tools. |
| Document number | : ASM-20220228-RAP114 |
| Status | : Definitive Concept |
| Date | : 2022 02 28 |
| Responsible Author(s) | : Sebastiaan. C.F. Meijer Ph.D. MSc., ASM Design B.V. |
| e-mail address | : meijer@asmdesign.nl |
| To | : Hrvatske Vode, Ulica grada Vukovara 220, 10000 Zagreb, Croatia |
| e-mail | : |



Content

| | |
|---|----|
| Content | 3 |
| 1 Management summary | 6 |
| 1.1 General project introduction | 6 |
| 1.2 Project goals | 7 |
| 1.3 Context of this report | 7 |
| 1.4 Background and previous investigations | 7 |
| 1.5 Reader | 8 |
| 1.6 General conclusions | 8 |
| 1.7 Recommendations | 8 |
| 2 Introduction | 9 |
| 2.1 Context of this report | 9 |
| 2.2 Background and previous investigations | 9 |
| 2.3 Reader | 10 |
| 3 Influent flow measurements | 11 |
| 3.1 Introduction and methods | 11 |
| 3.2 Winter influent flow measurement results | 11 |
| 3.3 Conclusions flow measurements | 13 |
| 4 Influent quality sampling | 14 |
| 4.1 Sampling method | 14 |
| 4.2 Measurement adjustments in the raw data | 14 |
| 4.3 Calculation method for the average influent concentration | 15 |
| 4.4 Influent concentration profiles | 16 |
| 4.5 COD Influent concentration - Winter 2022 | 16 |
| 4.6 Nitrogen influent concentration – Winter 2022 | 17 |
| 4.7 Phosphorus influent concentration – Winter 2022 | 19 |
| 4.8 Total Suspended Solids influent concentration – Winter 2022 | 21 |



| | | |
|-----|---|----|
| 4.9 | pH influent measurements - Winter 2022 | 22 |
| 5 | Influent loading profiles | 24 |
| 5.1 | Average influent loads | 24 |
| 5.2 | Influent COD 24-hour dynamic loading profile..... | 24 |
| 5.3 | Influent Nitrogen 24-hour dynamic loading profile..... | 25 |
| 5.4 | Influent Phosphorus 24-hour dynamic loading profile | 26 |
| 5.5 | Influent Total Suspended Solids 24-hour dynamic loading profile | 27 |
| 6 | Influent specification model..... | 29 |
| 6.1 | Determining fractions of influent concentrations | 29 |
| 6.2 | Results of the specification model | 30 |
| 6.3 | Conclusions | 31 |
| 7 | Model calibration and validation | 32 |
| 7.1 | Static calibration..... | 32 |
| 7.2 | Anoxic growth factors for OHO and PAO..... | 32 |
| 7.3 | DO half saturation | 33 |
| 7.4 | Particulate influent COD/VSS ratio | 33 |
| 7.5 | Parameters PAO updated to TUDP-model | 34 |
| 7.6 | Calibration results and discussion | 34 |
| 7.7 | Model validation | 36 |
| 7.8 | Conclusion dynamic simulations | 36 |
| 7.9 | Conclusions | 36 |
| 8 | Conclusions and recommendations..... | 38 |
| 8.1 | General conclusions | 38 |
| 8.2 | Summary of technical conclusions | 38 |
| 8.3 | Recommendations | 38 |
| | Appendix 1. Influent Concentrations Winter 2022 | 39 |
| | Appendix 2. Influent Load Winter 2022 | 39 |
| | Appendix 3. BioWin Model Influent Specification | 41 |
| | Results of the influent specification model | 41 |
| | Presenting the BioWin influent specification model | 46 |
| | Appendix 4. Winter 2022 results dynamic model validation..... | 52 |



| | |
|---|----|
| Winter operation process flow diagram | 52 |
| Average performance overview | 52 |
| Influent modelling results | 54 |
| Process and recycle flows modelling results..... | 55 |
| Waterline operation modelling results | 56 |
| Waterline concentration profiles modelling results | 57 |
| Aeration and DO concentration modelling results..... | 60 |
| pH and alkalinity profiles modelling results | 61 |
| Chemical load and flow modelling results..... | 62 |
| Sludge line operation modelling results..... | 62 |
| Effluent modelling results | 64 |
| Appendix 5: BioWin configuration data calibration 2022..... | 66 |



1 Sažetak izvješća

1.1 Uvod

Infrastrukturno ulaganje “Postrojenja za odvodnju i pročišćavanje otpadnih voda Grada Poreča” – Projekt Poreč, sufinanciran od strane Europske unije, jedna je od najvećih investicija u javnom sektoru u Republici Hrvatskoj. Uključuje sanaciju i proširenje postojećeg kanalizacijskog sustava te izgradnju četiri nova uređaja za pročišćavanje otpadnih voda (UPOV). Cilj je bolja zaštita okoliša u i oko porečkog priobalja. Komplementarno se razvija projekt pod nazivom „Integrirano modeliranje infrastrukturnog sustava otpadnih voda Grada Poreča” – Projekt modeliranja. Ovaj projekt je integrirana procjena utjecaja na okoliš radi boljeg razumijevanja utjecaja performansi sustava na okoliš koji se ocjenjuje u nizu radnih uvjeta. Studija scenarija je razvijena korištenjem najsuvremenijih “state-of-the-art” (modelskih) alata i metoda koje omogućuju holističku procjenu sustava otpadnih voda. Rezultati ovog istraživanja služe kao pomoć budućem poslovanju i gospodarenju otpadnim vodama u regiji te se koriste za podizanje znanja i profesionalnih vještina stručnjaka lokalnog vodnog sektora.

Projekt modeliranja sastoji se od 4 glavne komponente, i to:

- 1. dio: Modeliranje sustava prikupljanja i transporta otpadnih voda Grada Poreča,
- 2. dio: Modeliranje rada i rezultata pročišćavanja na 4 UPOV-a Grada Poreča,
- 3. dio: Model procjene utjecaja morskih ispusta na kvalitetu morske vode,
- 4. dio: Uspostava eksperimentalnog laboratorija za praćenje i optimizaciju upravljanja i rada otpadnih voda.

Uključujući trening organizira se kako bi se proširili kapaciteti stručnjaka u vodnom gospodarstvu u korištenju modeliranja sustava otpadnih voda za buduće procjene. Projekt modeliranja ima holistički sustavni pristup koji pokriva skupljanje, obradu i ispuštanje otpadnih voda u morsko okruženje, međuodnos između različitih sustava otpadnih voda i utjecaj na okoliš, javno zdravlje i kvalitetu obalne morske vode.

Nekoliko scenarija proračunato je kako bi se istražio utjecaj Projekta Poreč na prethodno navedene čimbenike te kako bi se uspostavile najbolje metode upravljanja sustavima otpadnih voda iz integrirane perspektive.

Modeliranjem se demonstrira kako nadogradnja porečkog sustava otpadnih voda poboljšava okoliš. Razvija se daljnji uvid u cjelokupnu interakciju podsustava o kvaliteti morske vode.

Kroz projekt se razvija i znanje o tome kako upravljati i optimizirati različite sustave otpadnih voda, s najboljim ukupnim rezultatima.



1.2 Sadržaj ovog izvješća

Ovo izvješće odnosi se na Projekt modeliranja 2. dio: Modeliranje rada i rada 4 UPOV Grada Poreča. Svaki UPOV se modelira i izvještava zasebno. Projekt modeliranja 2. dio razvijen je u četiri koraka, jedno izvješće po koraku za svaki pojedinačni UPOV.

- Korak 1: Statičko modeliranje UPOV na temelju detaljnog projekta. U ukupnom projektu ovo je izvješće broj 5, koje se sastoji od 4 pod-izvješća po jedno za svaki UPOV (izvješće broj 5.1 do 5.4).
- Korak 2: Dinamičko modeliranje UPOV na temelju dinamičkog mjerenja influenta tijekom zime i ljeta. U ukupnom projektu ovo je izvješće broj 6, koje se sastoji od 4 podizvješća po jedno za svaki UPOV (izvješće broj 6.1 do 6.4).
- Korak 3: Analiza operativnih scenarija UPOV. Ovo izvješće uzima rezultate prethodnih studija te je niz operativnih scenarija razvijeno i kvantificirano po opterećenjima i koncentracijama obalnog protoka (izvješće broj 7.1 do 7.4).
- Korak 4: Validacija modela na temelju operativnih mjerenja (obuhvaćeno ovim izvješćem 8.1 do 8.4). Kalibriranje i validiranje modela temeljeno je na novim mjerenjima tijekom pokretanja UPOV u rad tijekom siječnja 2022 godine. Model je validiran kroz reproduciranje novih podataka o kakvoći ulazne i pročišćene otpadne vode bez potrebe za značajnijom promjenom parametara modela.

1.3 Dosadašnji rezultati

Ovo podizvješće prikazuje process validiranja modela koji je razvijen u prethodnim koracima. Statičko kalibriranje je urađeno je sa uporabom novih podataka iz mjerenja kakvoće ulazne i pročišćene otpadne vode. Metodologija kalibriranja je shodna publiciranoj literaturi po opisu datom u izvješću broj 5 ove Studije. Princip i osnove kalibriranja dinamičkog modela date su u izvješću broj 6 ove Studije. Zaključeno je da je model zahtijevao vrlo malo promjena njegovih parametara, koji nisu kritični za rad modela i dobrano su u okviru standardnih vrijednosti datih BioWin programom. U izvješću broj 7 model je rabljen za izračun scenarija glede projektnog horizonta 2045 godine. Ovo izvješće broj 8 provjerava pretpostavke o vrijednostima parametara i validira njegovu primjenu. Kalibriranje i validiranje modela temeljeno je na novim mjerenjima tijekom pokretanja UPOV u rad tijekom siječnja 2022 godine. U poglavlju broj 3, mjereni dotok na UPOV-e je ocijenjen glede njegove primjene. U poglavlju broj 4, razmatrana je kakvoća ulazne otpadne vode (koncentracije onečišćenja u njoj) i rezultati uzorkovanja i mjerenja su pripremljeni za uporabu modela (privitak 1). Peto poglavlje daje prikaz masenog opterećenja otpadnih voda (privitak 2). Poglavlje broj 6 razmatra karakterizaciju influenta (privitak 3). Poglavlje 7 prikazuje rezultate kalibriranja i validiranja modela (privitak 4 i privitak 5). Mjereni podaci o efluentu iz 2022 godine su poređeni s rezultatima kalibriranog modela. Model je ocijenjen zadovoljavajućim kad su dobijeni rezultati glede kakvoće efluenta ponovljeni bez značajne promjene stoihiometrijskih parametara modela. U sva 4 slučaja u ovoj Studiji, fino kalibriranje nekoliko parametara je bilo neophodno da bi se dobili zadovoljavajući rezultati za određene uvjete rada UPOV. Na primjer, uvjete mješanja ili kontrola aeriranja je trebalo podesiti u procesu validiranja. To je zahtijevalo i blagu promijenu nekih kinetičkih parametara u modelu, ali sve u očekivanim rasponima standardnih vrijednosti datih BioWin programom.



1.4 Opći zaključci

- Model je uspješno provjeren koristeći neovisan paket podataka i svi su rezultati provjereni i potvrđeni bez značajnije promjene parametara u modelu.
- Model je ocijenjen kao postojan i spreman za primjenu za ocjenu scenarija.
- Gornji zaključci su primjenjivi na sve prikazane rezultate u prethodnim koracima modeliranja (izvješće broj 6 i izvješće broj 7).

1.5 Glavna preporuka

Preporuča se nastaviti s daljnjim razvojem studije scenarija i modeliranja morske vode uzimajući u obzir prikazane rezultate i zaključke.



1 Management summary

1.1 General project introduction

The infrastructural investment “Sewerage and Wastewater Treatment Plants of City of Poreč”– Project Poreč, co-funded by European Union, is one of the largest investments in the public sector in Republic of Croatia. It involves rehabilitation and extension of the existing sewerage system and construction of four new wastewater treatment plants (WWTPs). The goal is to better protect the environment in and around the Poreč coastal area. Complementary a project is developed titled “Integrated Modelling of Wastewater Infrastructure System of City of Poreč” – Modelling Project. This project is an integrated environmental assessment to obtain a better understanding of the environmental impact of the system performance which is evaluated under range of operational conditions. A scenario study is developed using state-of-the-art (modelling) tools and methods which allows a holistic assessment of the wastewater system. The results of this study are in assistance of future operations and wastewater management in the region and used to elevate knowledge and professional skills of local water sector professionals.

The Modelling Project consists of 4 main components, namely:

- Part 1: Modelling the sewage collecting and transport system of City of Poreč,
- Part 2: Modelling of operation and performance of 4 WWTPs of City of Poreč,
- Part 3: Model assessment impact offshore outlets on aquatic water quality,
- Part 4: Establishment of the experimental laboratory setup for monitoring and optimization of wastewater management and operation.

Including a training is organized to extend the capacity of water professionals in the use of wastewater modelling for future assessments.

The Modelling project has a holistic system approach covering collection, processing, and aquatic discharge of wastewater, the interrelation between the different wastewater systems and impact on the environment, public health, and coastal seawater quality.

Several scenarios are calculated to explore the impact of Project Poreč on the previous mentioned factors and to and establish the best methods for management of the wastewater systems from an integrated perspective.

Modelling is used to demonstrate how upgrade of the Poreč wastewater system improves the environment. Further insight is developed in the overall interaction of the sub-systems on seawater quality. Knowledge is developed on how to operate and optimize the different wastewater systems, with the best overall results.



1.2 Project goals

The overall objective of the Poreč modelling project is to demonstrate how upgrading the total wastewater system improves the sea water quality in the Poreč coastal region.

Therefore, the total wastewater system is modelled consisting of several sub-systems. By modelling the WWTP under different (extreme) conditions it is investigated how effluent discharge load and quality will affect the sea water quality. For each studied scenario, effluent concentration and flow profiles are calculated. These data are subsequently used as input for sea water quality modelling from which the environmental impact is calculated.

1.3 Context of this report

This report belongs to the reports in the series “modelling project part 2: Modelling of operation and performance of 4 WWTPs of City of Poreč”. Each WWTP is modelled and reported in a series of 4 documents of which this is the final. For accessibility the reports are set up using identical format and methods. Modelling project Part 2 is developed in four steps:

- Step 1: Static WWTP modeling using detailed design data. In the total project this is report number 5 consisting of 4 sub-reports, one for each WWTP (report number 5.1 to 5.4).
- Step 2: Dynamic WWTP modeling based on dynamic winter and summer influent measurements (data 2019). In the total project this is report number 6, consisting of 4 sub-reports, one for each WWTP (report number 6.1 to 6.4).
- Step 3: Analysis of operational WWTP scenarios up to the year 2045. In this step a series of operational scenarios are developed, and the potential coastal discharge loads and concentrations are quantified based on extrapolation simulations. In the total project this is report number 7, consisting of 4 sub-reports, one for each WWTP (report number 7.1 to 7.4).
- Step 4 (this report series): Model calibration and validation based on new operational measurements done in 2022. The model validity is tested by reproducing a new influent and effluent data set without the need of significant model adjustments. In the total project this is report number 8, consisting of 4 sub-reports one for each WWTP (report number 8.1 to 8.4).

1.4 Background and previous investigations

This research is part of an integrated environmental assessment of the wastewater transport, collecting and treatment system including the coastal recipient. The goal of this research is to obtain a better understanding of the environmental impact of modernization of the City of Poreč wastewater system and its performance. This report is part of a series studying the operation of 4 wastewater treatment plants of the larger City of Poreč. Models of the wastewater treatment are developed from detailed design information and influent flow and concentration data are measured in the summer and winter of 2019 and winter of 2022. In previous reports (numbered report 5, 6 and 7) model evaluations have been performed simulating a range of operational conditions and future scenarios. In report number 5 the average performance is evaluated using a static model. In report number 6



models are further developed to test and evaluate operation under realistic dynamic conditions. In report number 7 models are projected towards winter and summer conditions in 2045 including a dynamic scenario with peak loading and rain event. Based on the simulations results, the impact of the upgraded wastewater facilities on the coastal seawater quality is assessed. In this report the validity of the previously developed models is further investigated by calibrating the model using a new dataset measured in 2022, including operational performance data. It is tested if the previously developed dynamic model can reproduce measured effluent quality without having to alter critical model parameters. The study adds to the overall validity of the previously performed model calculations and scenario projections.

1.5 Reader

This report presents the validation of the previously developed model. Therefore, a static calibration is performed using a new 2022 operational dataset with influent and effluent measurements. The calibration methodology is according to published literature and explained in report 5 of this series. The setup and calibration of the dynamic model is explained in report 6. It was concluded that the model required little parameter adjustments, all not critical and well within the advised settings (default BioWin). In report 7 the model is used for scenario calculations towards the year 2045. This report tests the assumptions for the parameter settings and validates its application. The model settings are validated by calibrating the model using a new operational dataset with influent and effluent data measured in the winter of 2022. In chapter 3 the 2022 measured flow data is evaluated and presented for model application. In chapter 4 the influent quality sampling (concentrations) is discussed, and measurement results are presented and prepared for model application (appendix 1). Chapter 5 presents the influent (mass) loading profiles (appendix 2). Chapter 6 discusses the influent characterization results (appendix 3). Chapter 7 presents the model calibration and validation (appendix 4 and 5). Measured 2022 effluent results are compared with results of the calibrated model. The model is determined to be valid when effluent values are reproduced without significant adjustment of (stoichiometric) parameters. For all model studies some finetuning is necessary to reproduce specific operational conditions. For example, mixing conditions or aeration controller settings. Therefore, some kinetic parameters are adjusted within a typical range.

1.6 General conclusions

- The model is tested successfully on an independent data set and reproduced all data without significant adjustments.
- The model is tested reliable and validated for use for operational and scenario evaluation.
- The above conclusions apply to all presented results, under which previous WWTP modelling reports published in this series, which have used the validated model.

1.7 Recommendations

It is recommended to proceed with final development of the scenario analysis and sea water modelling taking in account the presented conclusions.



2 Introduction

2.1 Context of this report

This report belongs to the reports in the series “modelling project part 2: Modelling of operation and performance of 4 WWTPs of City of Poreč”. Each WWTP is modelled and reported in a series of 4 documents of which this is the final. For accessibility the reports are set up using identical format and methods. Modelling project Part 2 is developed in four steps:

- Step 1: Static WWTP modeling using detailed design data. In the total project this is report number 5 consisting of 4 sub-reports, one for each WWTP (report number 5.1 to 5.4).
- Step 2: Dynamic WWTP modeling based on dynamic winter and summer influent measurements (data 2019). In the total project this is report number 6, consisting of 4 sub-reports, one for each WWTP (report number 6.1 to 6.4).
- Step 3: Analysis of operational WWTP scenarios up to the year 2045. In this step a series of operational scenarios are developed, and the potential coastal discharge loads and concentrations are quantified based on extrapolation simulations. In the total project this is report number 7, consisting of 4 sub-reports, one for each WWTP (report number 7.1 to 7.4).
- Step 4 (this report series): Model calibration and validation based on new operational measurements done in 2022. The model validity is tested by reproducing a new influent and effluent data set without the need of significant model adjustments. In the total project this is report number 8, consisting of 4 sub-reports one for each WWTP (report number 8.1 to 8.4).

2.2 Background and previous investigations

This research is part of an integrated environmental assessment of the wastewater transport, collecting and treatment system including the coastal recipient. The goal of this research is to obtain a better understanding of the environmental impact of modernization of the City of Poreč wastewater system and its performance. This report is part of a series studying the operation of 4 wastewater treatment plants of the larger City of Poreč. Models of the wastewater treatment are developed from detailed design information and influent flow and concentration data are measured in the summer and winter of 2019 and winter of 2022. In previous reports (numbered report 5, 6 and 7) model evaluations have been performed simulating a range of operational conditions and future scenarios. In report number 5 the average performance is evaluated using a static model. In report number 6 models are further developed to test and evaluate operation under realistic dynamic conditions. In report number 7 models are projected towards winter and summer conditions



in 2045 including a dynamic scenario with peak loading and rain event. Based on the simulations results, the impact of the upgraded wastewater facilities on the coastal seawater quality is assessed. In this report the validity of the previously developed models is further investigated by calibrating the model using a new dataset measured in 2022, including operational performance data. It is tested if the previously developed dynamic model can reproduce measured effluent quality without having to alter critical model parameters. The study adds to the overall validity of the previously performed model calculations and scenario projections.

2.3 Reader

This report presents the validation of the previously developed model. Therefore, a static calibration is performed using a new 2022 operational dataset with influent and effluent measurements. The calibration methodology is according to published literature and explained in report 5 of this series. The setup and calibration of the dynamic model is explained in report 6. It was concluded that the model required little parameter adjustments, all not critical and well within the advised settings (default BioWin). In report 7 the model is used for scenario calculations towards the year 2045. This report tests the assumptions for the parameter settings and validates its application. The model settings are validated by calibrating the model using a new operational dataset with influent and effluent data measured in the winter of 2022. In chapter 3 the 2022 measured flow data is evaluated and presented for model application. In chapter 4 the influent quality sampling (concentrations) is discussed, and measurement results are presented and prepared for model application (appendix 1). Chapter 5 presents the influent (mass) loading profiles (appendix 2). Chapter 6 discusses the influent characterization results (appendix 3). Chapter 7 presents the model calibration and validation (appendix 4 and 5). Measured 2022 effluent results are compared with results of the calibrated model. The model is determined to be valid when effluent values are reproduced without significant adjustment of (stoichiometric) parameters. For all model studies some finetuning is necessary to reproduce specific operational conditions. For example, mixing conditions or aeration controller settings. Therefore, some kinetic parameters are adjusted within a typical range.



3 Influent flow measurements

3.1 Introduction and methods

The influent flow is measured for 24-hours (1 day) with measurement points produced every 2 hours based on a collected flow sample for all 4 treatment locations. The measurement period for WWTP Poreč-South and WWRP Vrsar starts Monday 17-01-2022 at 9:00 and for WWTP Poreč-North and WWRP Lanterna starts Tuesday 18-01-2022 at 9:00. The measurement day was with dry weather. There are no missing datapoints and the measured did not require data to be reconstructed. From the measured flow profile an hourly average flow is calculated for each hour of the day. The profile is used as an input for dynamic modeling.

3.2 Winter influent flow measurement results

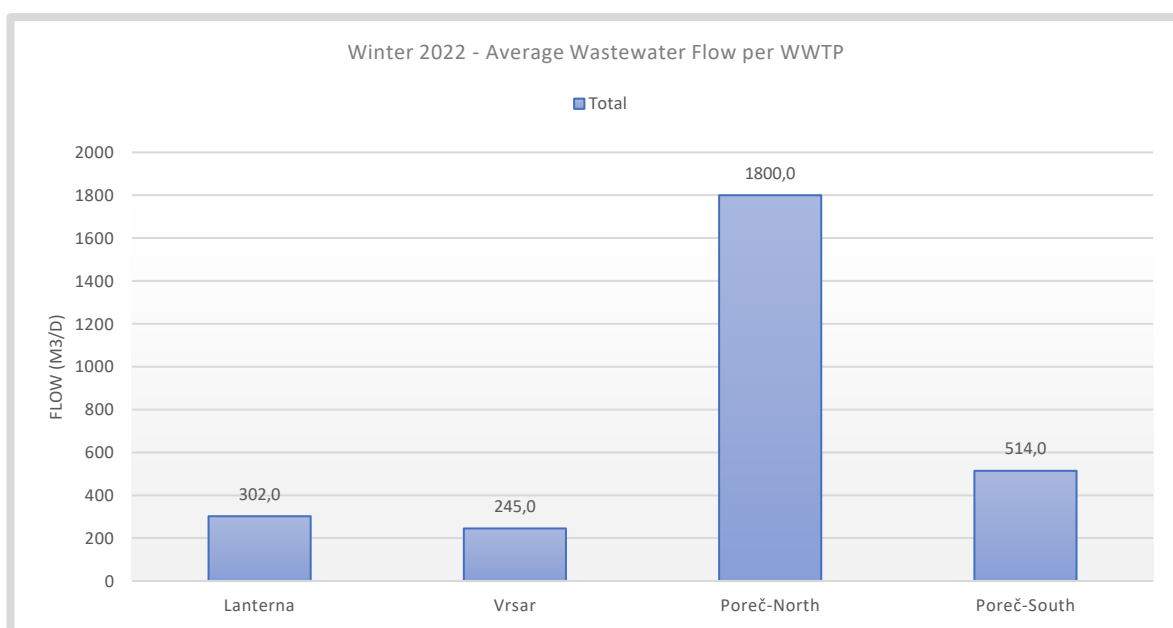

Figure 1. Winter 2022 - Average Dry Weather Wastewater Flow per WWTP.



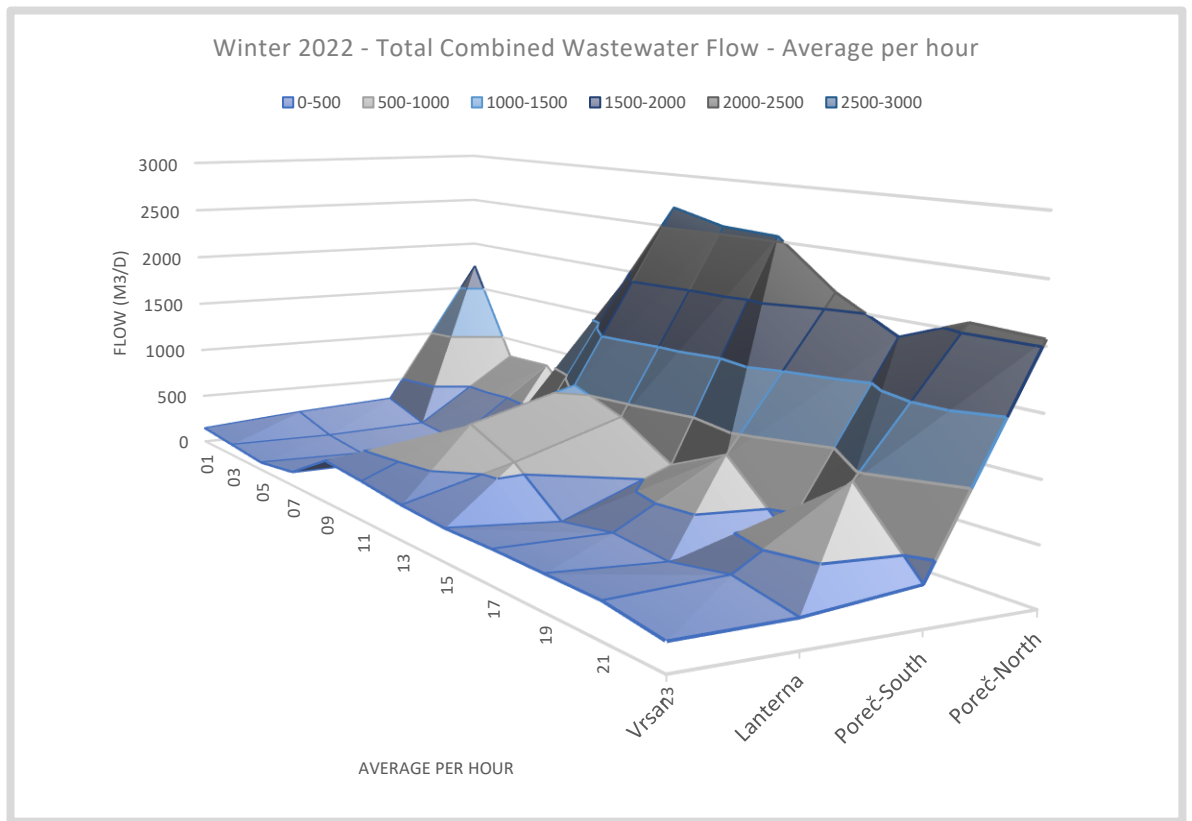

Figure 2. Winter 2022 - Surface plot of the total combined wastewater flow. The order of WWTP's is from lowest to highest wastewater producing community.

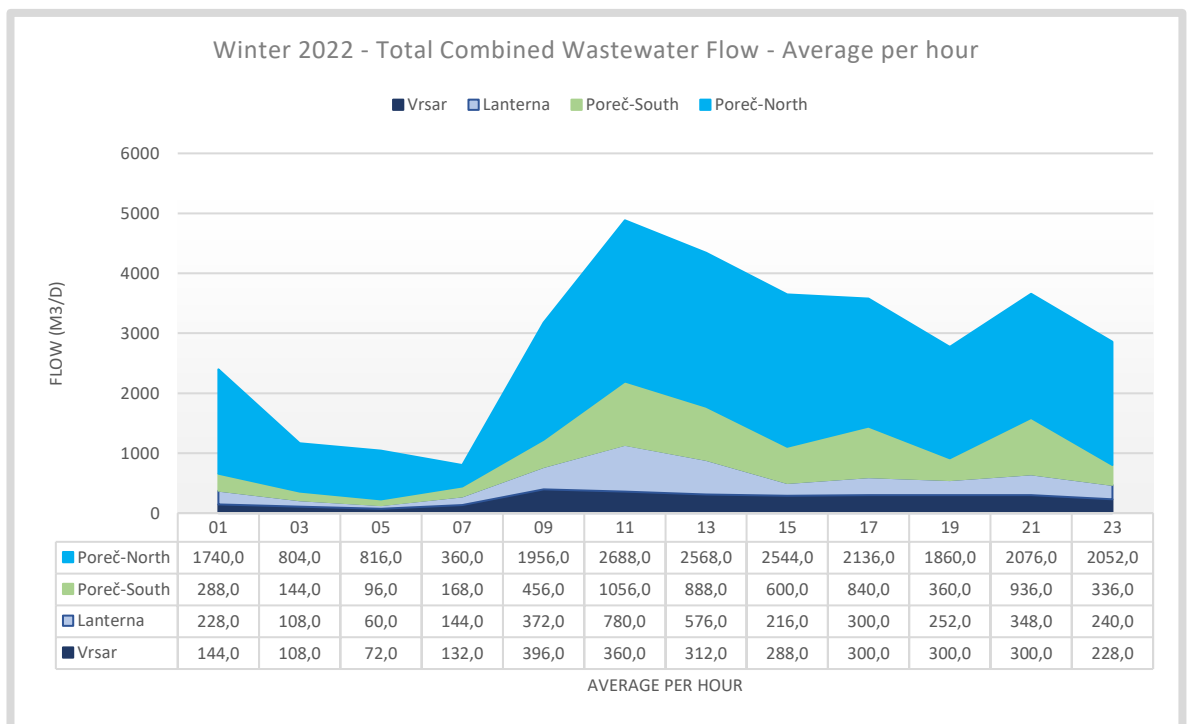

Figure 3. Winter 2022 - Total (sum of WWTP's) of the wastewater flow per hour.



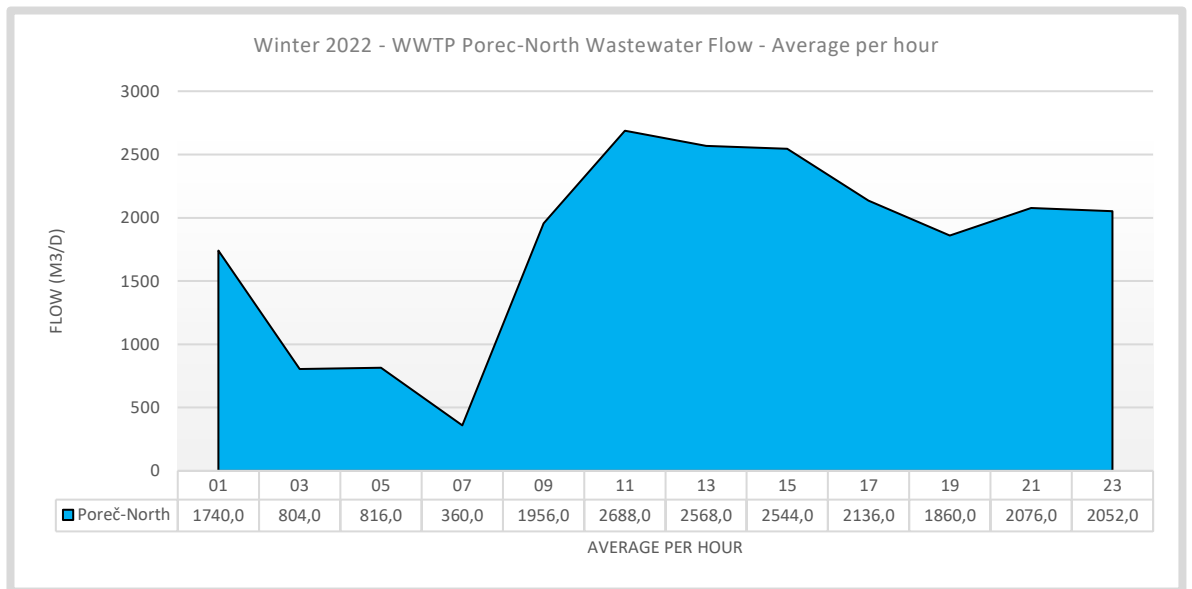

Figure 4. Winter 2022 - WWTP Poreč-North Dry Weather Wastewater Flow 24-hour average hourly measurements.

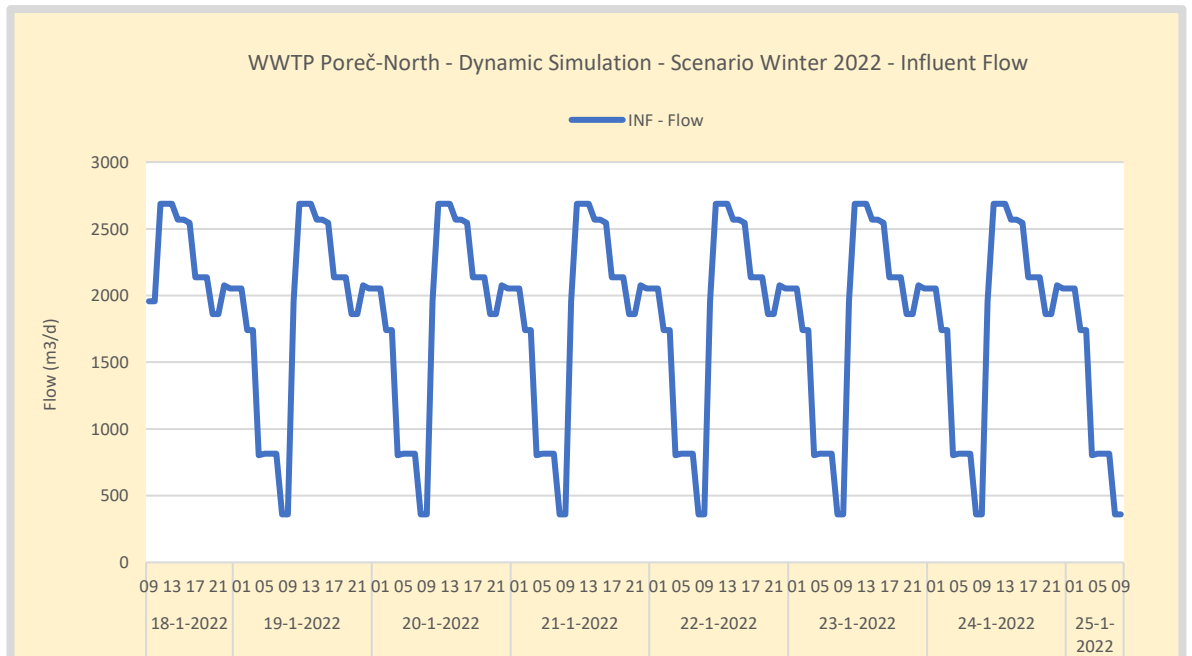

Figure 5. Winter 2022 - BioWin modelling WWTP Poreč-North: Wastewater Flow measured 24-hours and repeated for 7-days used for dynamic model input. The data is interpolated in the model on an hourly basis.

3.3 Conclusions flow measurements

Influent dry weather flow data measured in the winter of 2019 and 2022 are comparable. There is similarity in the minimum and maximum flow data as well as the flow distribution pattern over the day on an hourly basis. The profile is used in the calibration study to validate the model performance.



4 Influent quality sampling

4.1 Sampling method

Raw sewage wastewater is sampled at 4 WWTP locations; WWTP Poreč-North, WWTP Poreč-South, WWRP Vrsar and WWTP Lanterna. Continuous 24-hour automated samplers are used for a continued period of 24 hours. Per WWTP approximately 180 samples are collected and analyzed. Some by on-line measurement. The measurement period for WWTP Poreč-South and WWRP Vrsar starts Monday 17-01-2022 at 9:00 and for WWTP Poreč-North and WWTP Lanterna starts Tuesday 18-01-2022 at 9:00. During the measurement period there was absence of rain.

The type of wastewater sampler used is Hach AS950 Portable Sampler and WaterSam Ports. Samples are taken every 9-30 minutes (flow proportional) in bottles of volume 550–800 mL which are rotated automatically every 2 hours, for 24 h (total of 12 vessels collected per 24 hours for each sampling location). After a day of operation, samples are taken to the laboratory for analysis (Zagreb Laboratory for Water Technology at the Faculty of Food Technology and Biotechnology). Samplers are thermally insulated and refrigerated to preserve the samples and reduce occurring reactions.

Table 1. Parameters measured in wastewater.

| Parameters determined in the wastewater of the city of Poreč. | | | | |
|---|---|-------------------|------------------|---|
| Code | Parameter | 2h/24h composite | Filtered / Total | Chemical analysis method |
| TCOD | Total Chemical Oxygen Demand | 2 hour composite | Total sample | ISO 6060-1989 |
| CODMF | Chemical Oxygen Demand in filtrate (1.2 µm) | 2 hour composite | Micro filtered | ISO 6060-1989 |
| TN | Total nitrogen | 2 hour composite | Total sample | EN ISO 11905-1 decomposition s peroxodisulfate |
| PO4 | Orthophosphate | 2 hour composite | | DIN EN ISO 6878 |
| NH4 | Ammonia | 2 hour composite | | ISO 7150-1 |
| TSS | Total suspended solids | 2 hour composite | Total sample | Filtered, dried, weight |
| VSS | Volatile suspended solids (organic) | 2 hour composite | | Total solids minus inorganic fraction |
| ISS | Inorganic suspended solids | 2 hour composite | | Filtered, dried, weight, incinerated at 500 C, weight |
| pH | pH | 2 hour composite | | |
| EC | Electrical conductivity | 2 hour composite | | |
| BOD | Biological Oxygen demand over 5 days | 24 hour composite | Total sample | Test run over 5 days |
| BODMF | Biological Oxygen demand over 5 days in filtrate (1.2 µm) | 24 hour composite | Micro filtered | Test run over 5 days |
| TP | Total phosphorus | 24 hour composite | Total sample | EN ISO 6878 |
| NO3 | Nitrate | 24 hour composite | | ISO 7890-1-2-1986 |
| NO2 | Nitrite | 24 hour composite | | EN ISO 26777 |

4.2 Measurement adjustments in the raw data

For the influent data some datapoints are corrected.

- TKN measured at 5:00 and 7:00 19-01-2022 are half of the expected concentration and corrected accordingly.



- NH4 measured 21:00 hours 18-01-2022 is higher than TKN which is not possible, and the measured NH4 value is reduced by 10%.
- Influent TSS in the period 18-01-2022 13:00 till 19-01-2022 1:00 hour is too high in relation to BOD and COD measured in the same samples. The concentration values are reduced by 23% to get more typical values for the TSS/COD and TSS/BOD ratio.
- ISS measured 18-01-2022 13:00 is 3 times higher than normal and reduced accordingly to fit typical conditions. VSS is calculated from TSS and ISS and therefore simultaneously adjusted.

Measurement errors in TSS typical the result of non-homogeneous samples. Especially the larger heavier fraction will settle if the mixing conditions in a sewage sampling point are not ideal. COD is less affected because the COD is related to smaller and lighter particulate (colloidal) fraction that settles less rapidly and is less susceptible for mixing conditions.

4.3 Calculation method for the average influent concentration

For each 2-hour composite sample the flow volume is measured and concentration measured of all parameters in table 1. From these data every 2 hours the influent loads are calculated for each parameter. From the load profile the flow proportional (weighed) influent concentrations are calculated. Only weighed concentration are used in the model calculations. The results are presented in the following graphs.

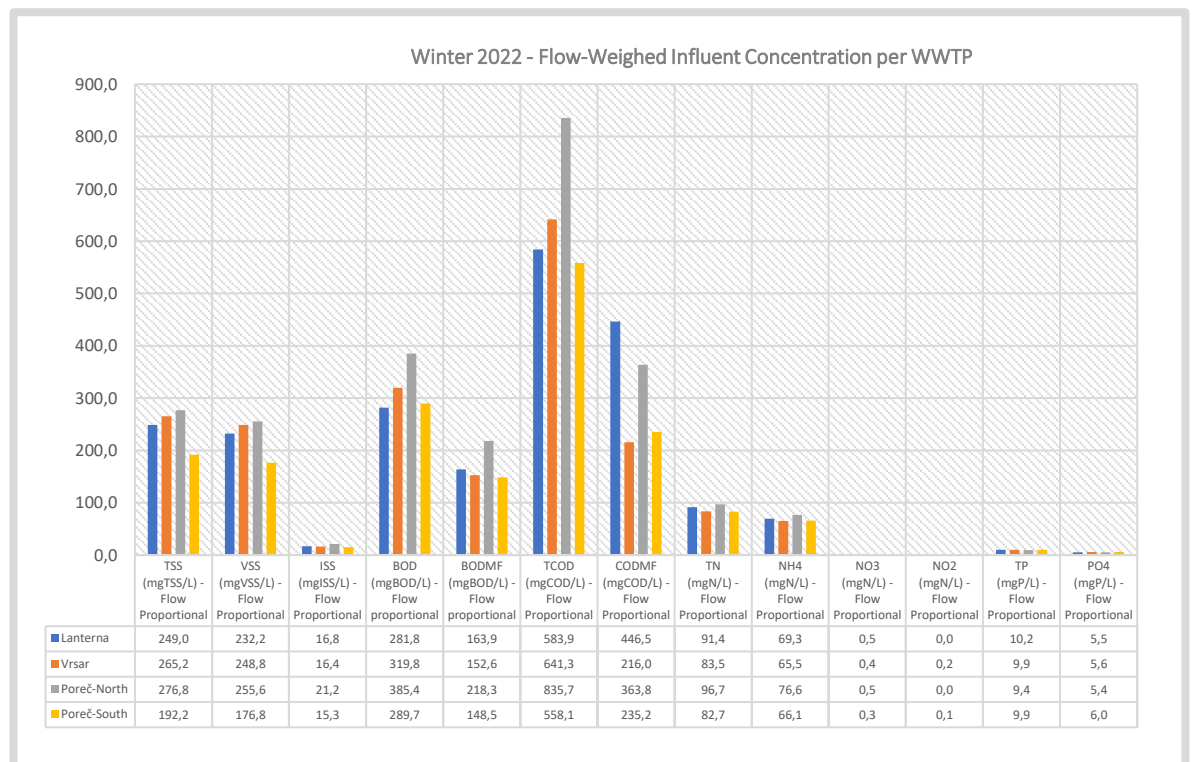

Figure 6. Winter 2022 - Flow-weighted average influent concentrations per WWTP.



4.4 Influent concentration profiles

The concentration of wastewater varies over time due to all kind of disturbances but most important population behavior. Human regular activity results in a distinctive measurement profile. For each measured parameter daily profiles are calculated and presented in the figures below. Measured concentration peaks are related to the sewage flow. High flow results in short sewer residence time and high concentration peaks early in the day while low flow results in lower peaks occurring later in the day. Transport of particulate material is very much dependent on the flow velocity in the sewer system. During the winter low flow season, it takes longer before particulate material arrives at the WWTP. This material settles overnight in the sewer and is collected in the morning when the flow increases. Ammonia and orthophosphate peaks in the morning as the result of human source urine. The time on which peaks are measured at the WWTP starting from 6 hours in the morning, indicates the residence time in the sewer system. This effect is observed from the data in the figures below.

4.5 COD Influent concentration - Winter 2022

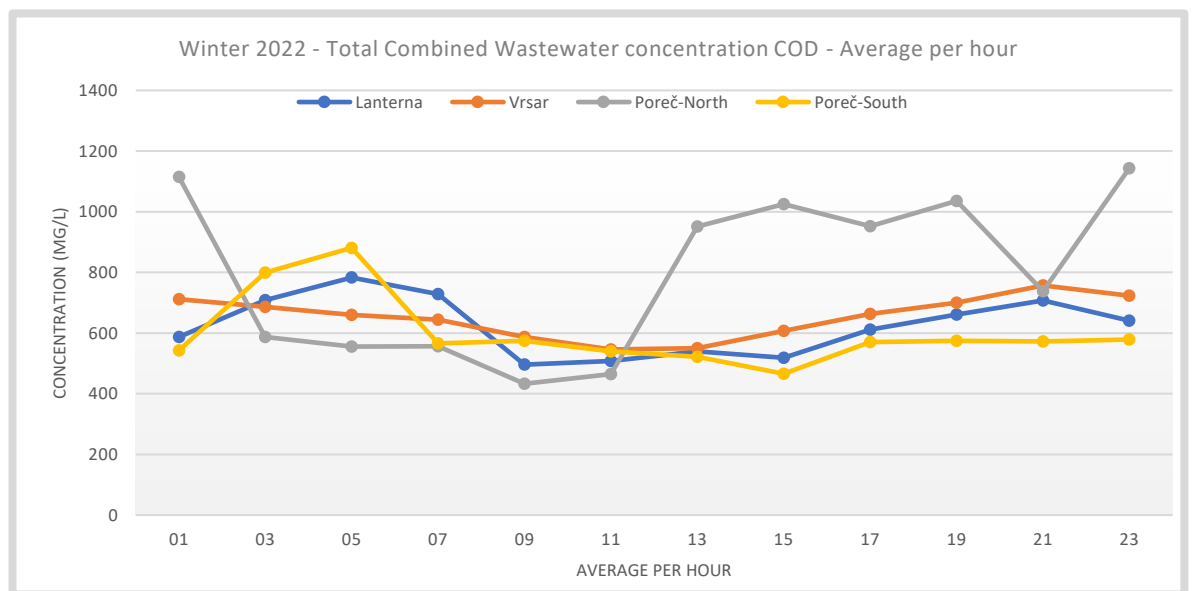

Figure 7. Winter 2022 - 24-hour COD Influent Concentration profile per WWTP.



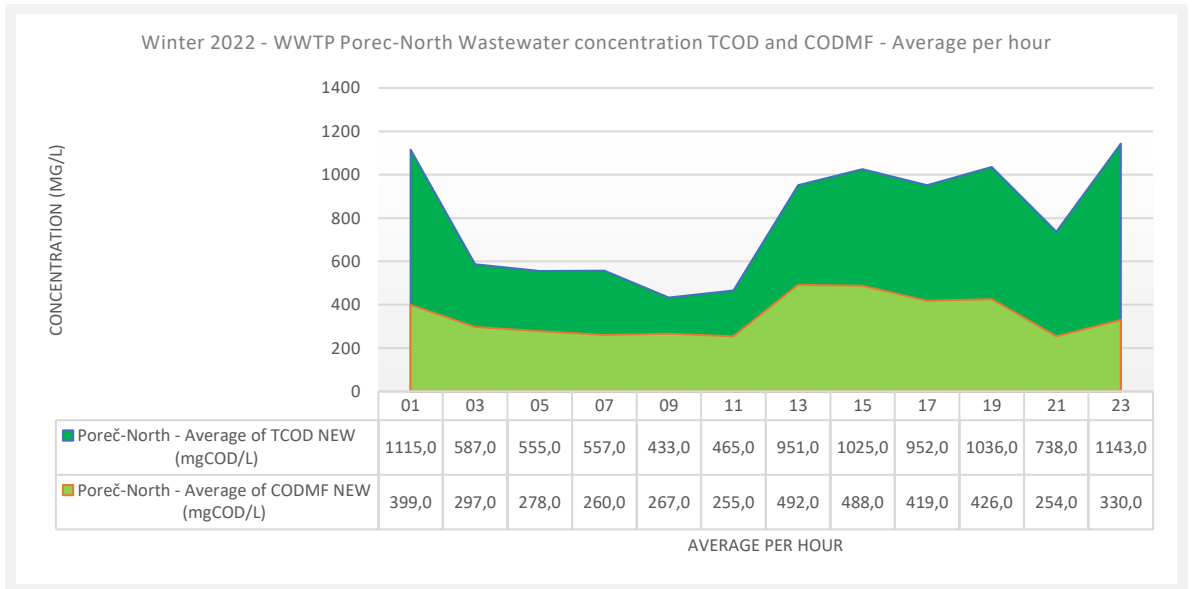

Figure 8. Winter 2022 - WWTP Poreč-North 24-hour average COD and COD micro-filtered influent Concentration.

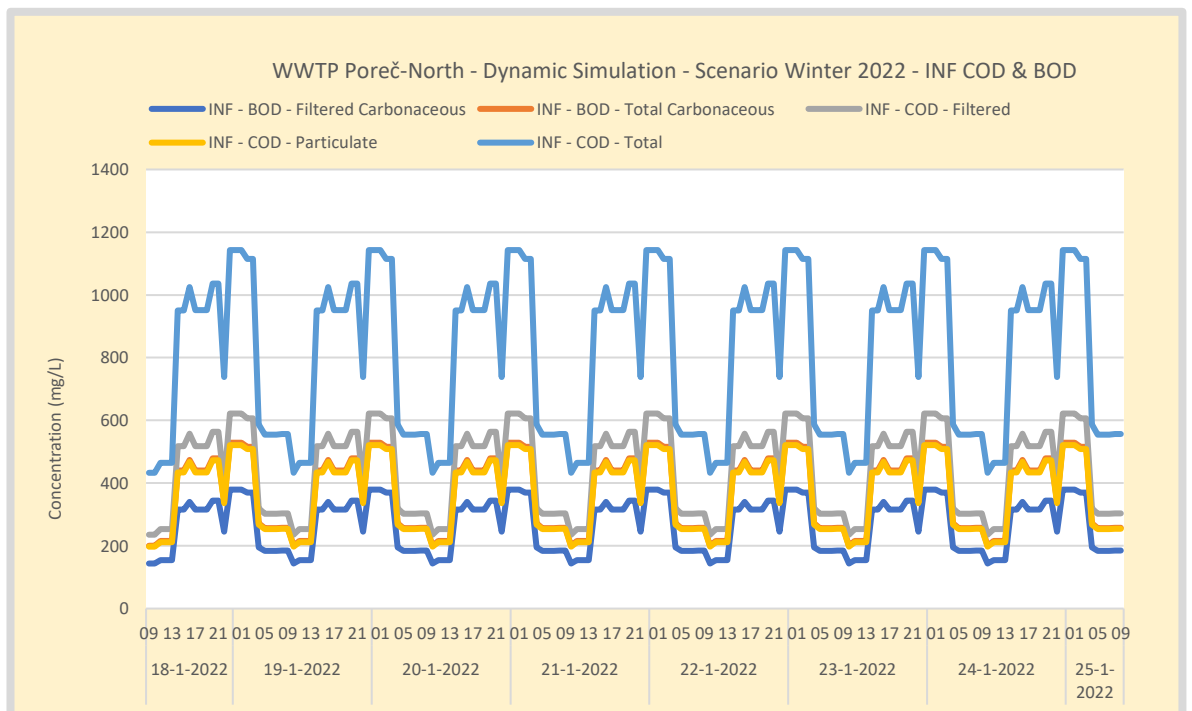

Figure 9. Dynamic Simulation – WWTP Poreč-North – Winter 24-hour average COD, COD micro-filtered, COD particulate, BOD and BOD filtered influent concentration. One day of measurement is repeated for 7 days in the dynamic simulation. The model input is the measured total COD concentration. Other fractions are calculated from the influent specification.

4.6 Nitrogen influent concentration – Winter 2022



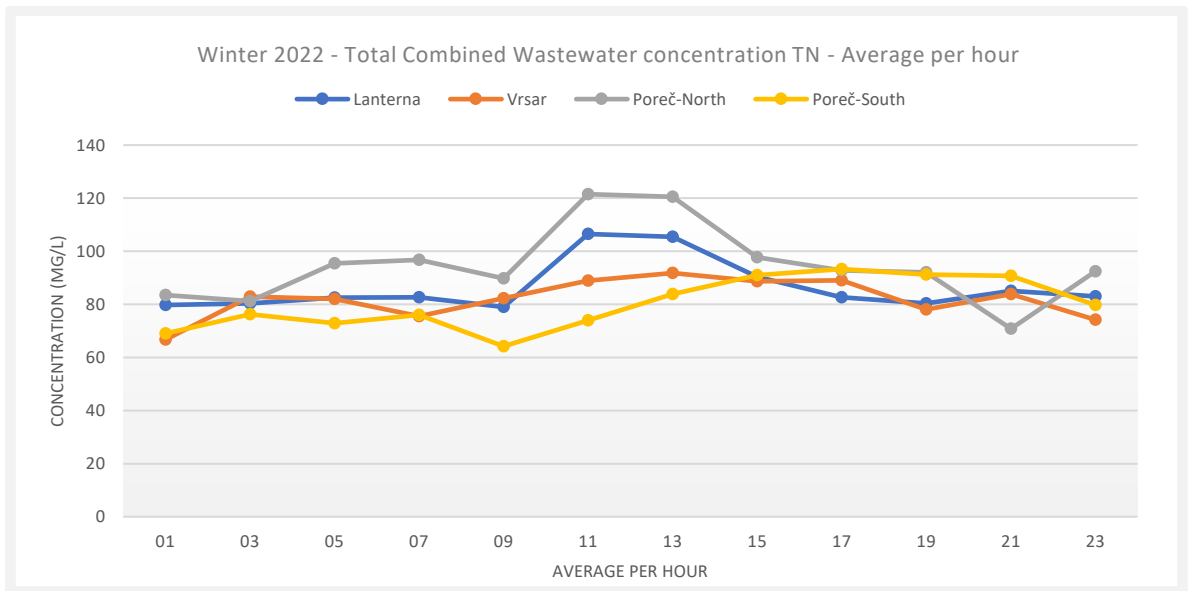

Figure 10. Winter 2022 - 24-hour TN Influent Concentration profile per WWTP.

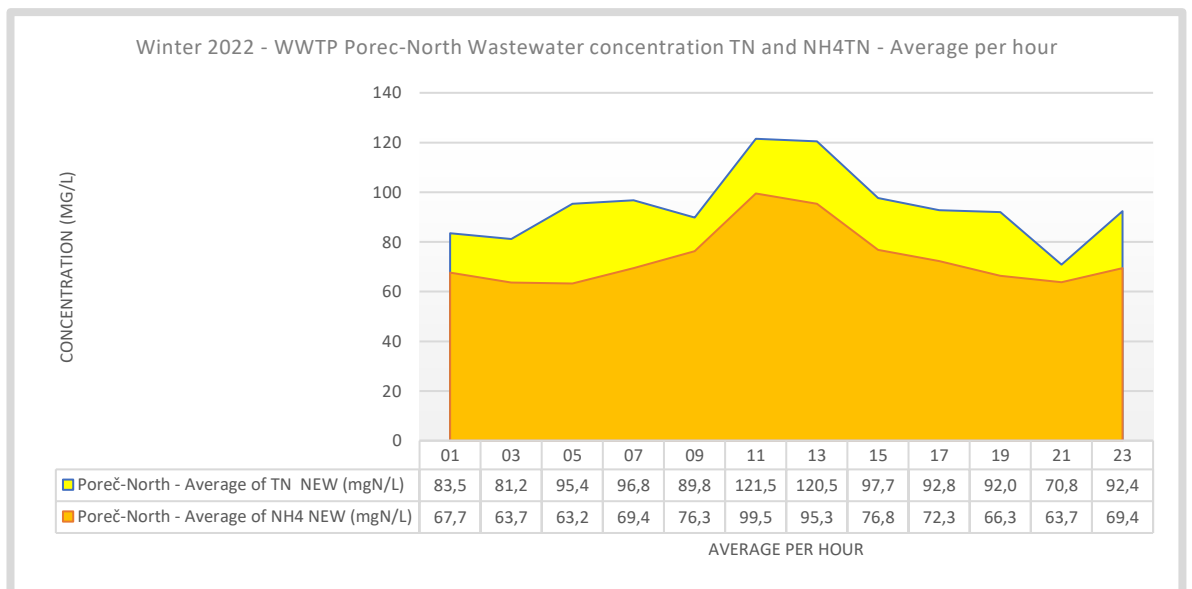

Figure 11. Winter 2022 - WWTP Poreč-North 24-hour average TN and NH4 influent Concentration.



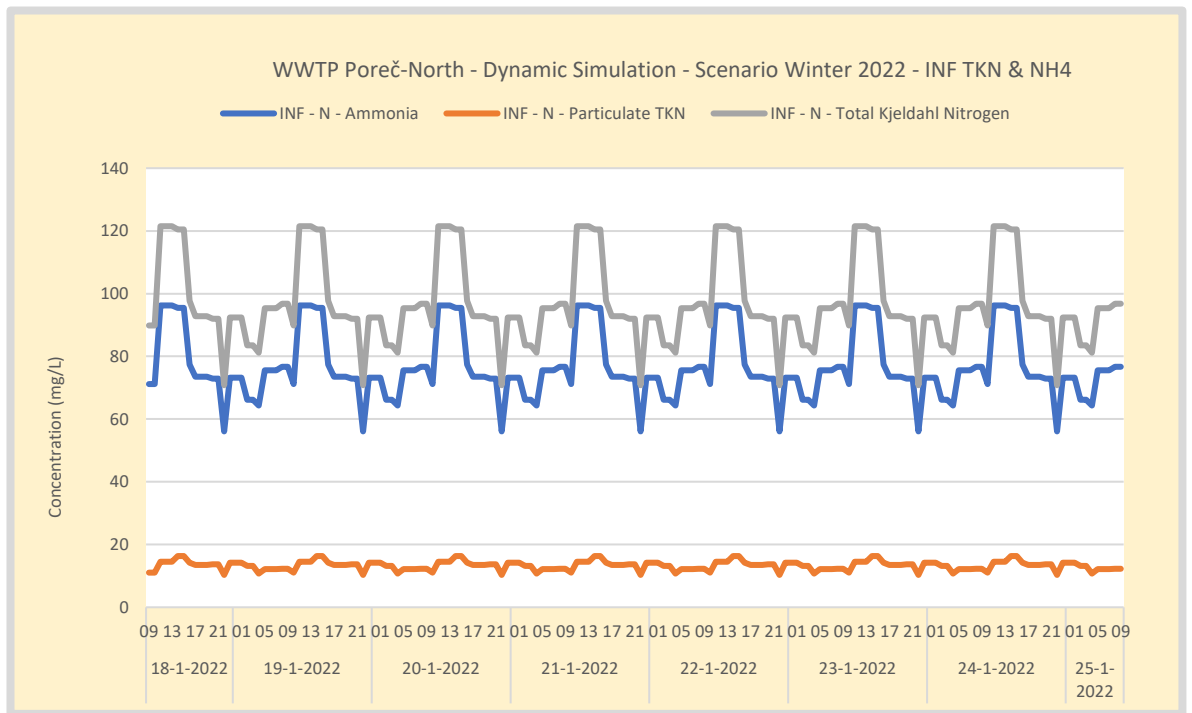

Figure 12. Dynamic Simulation – WWTP Poreč-North – Winter 24-hour average TKN, NH4 and particulate TKN influent concentration. One day of measurement is repeated for 7 days in the dynamic simulation. The model input is the measured TKN concentration. The other fractions are determined from the influent specification.

4.7 Phosphorus influent concentration – Winter 2022

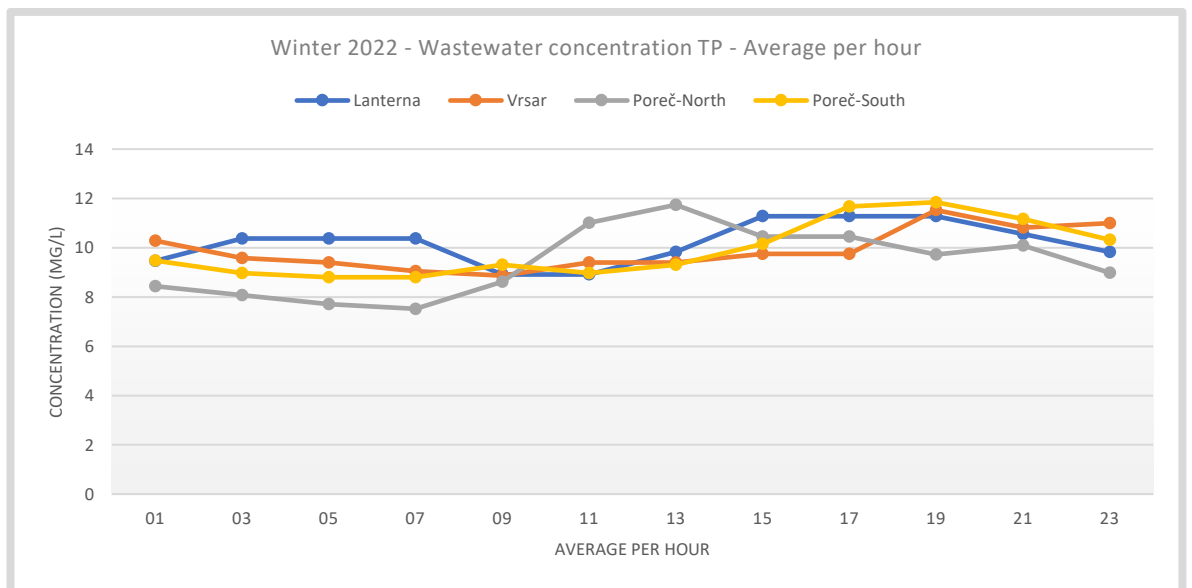

Figure 13. Winter 2022 - 24-hour TP influent concentration profile per WWTP.



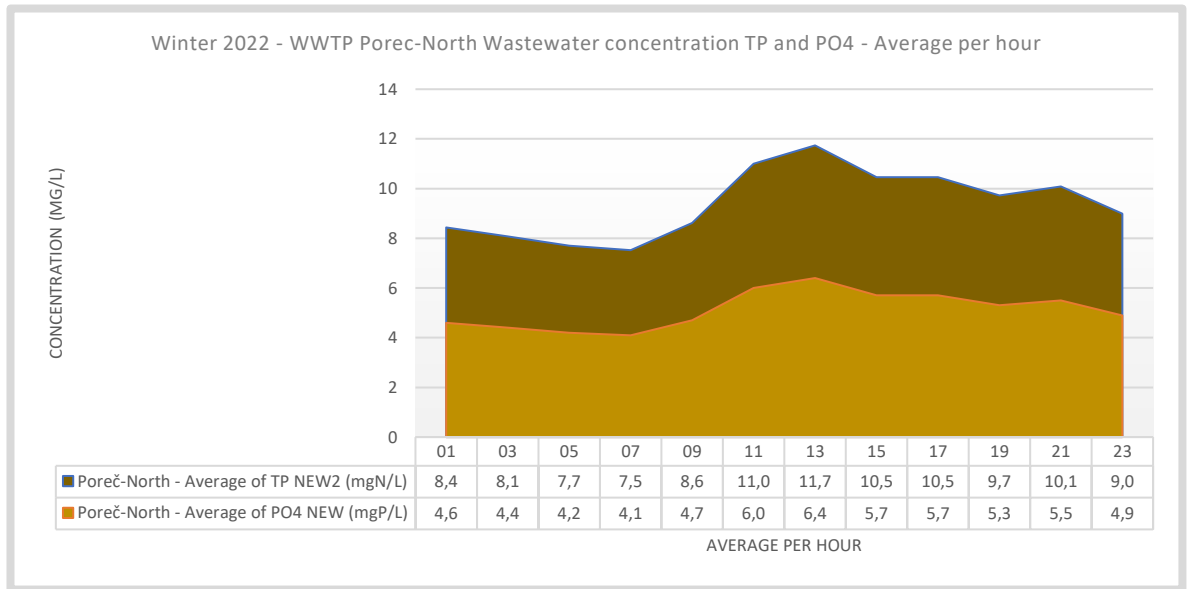

Figure 14. Winter 2022 - WWTP Poreč-North 24-hour average TP and PO4 influent concentration.

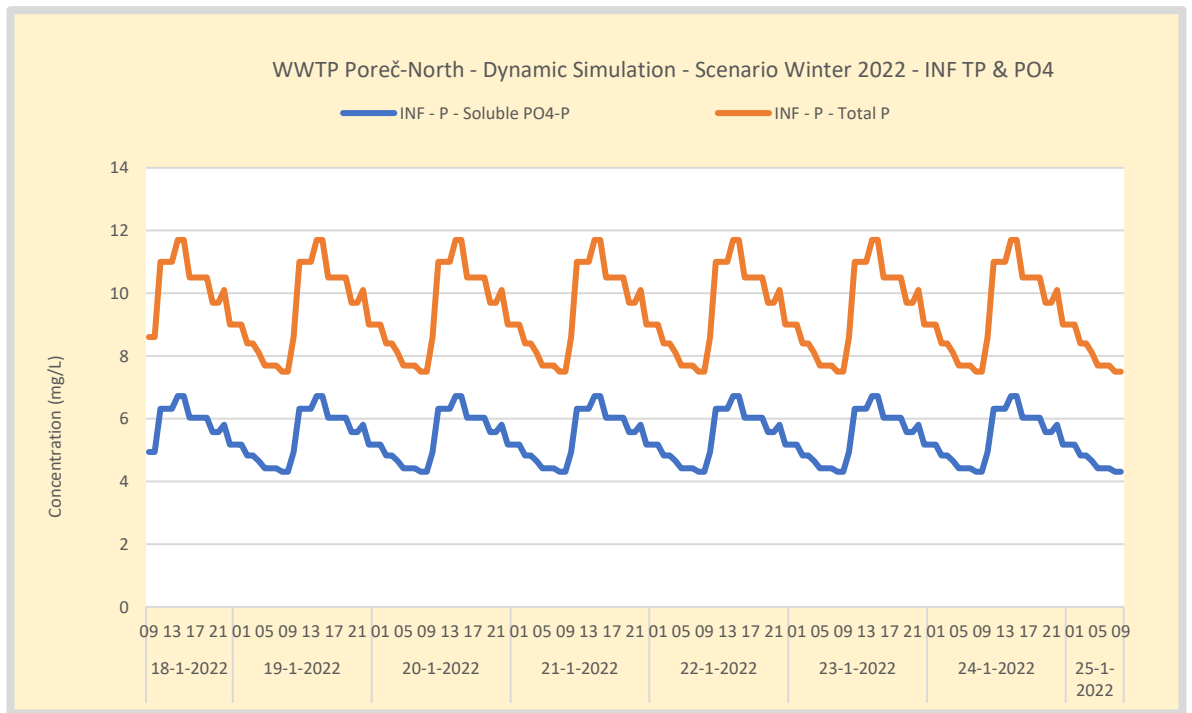

Figure 15. Dynamic Simulation – WWTP Poreč-North – Winter 24-hour average TP and PO4 influent Concentration. The model input is the measured TP concentration. One day of measurement is repeated for 7 days in the dynamic simulation. PO4 is determined from the influent specification.



4.8 Total Suspended Solids influent concentration – Winter 2022

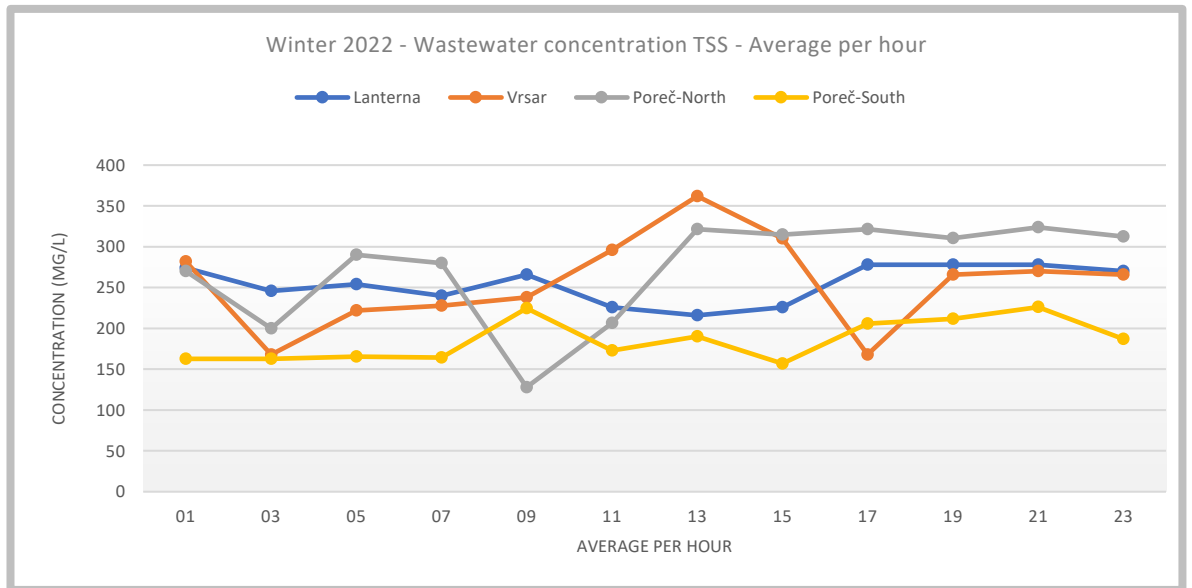

Figure 16. Winter 2022 - 24-hour TSS influent concentration profile per WWTP.

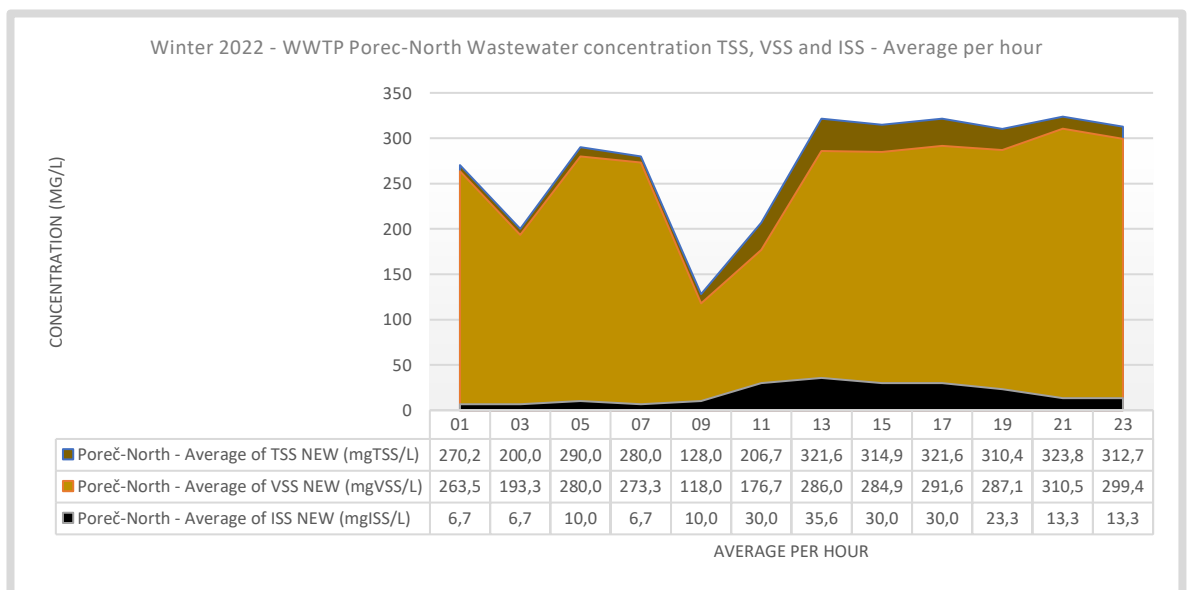

Figure 17. Winter 2022 - WWTP Poreč-North 24-hour average TSS, VSS and ISS influent concentration.



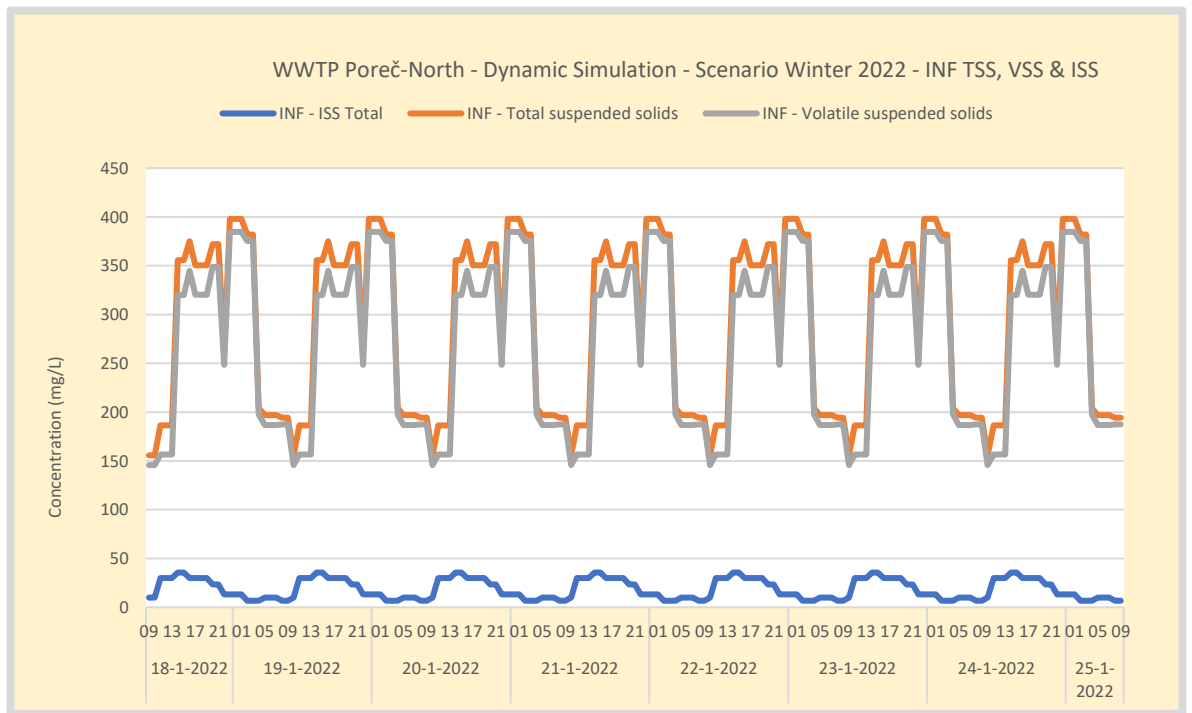

Figure 18. Dynamic Simulation – WWTP Poreč-North – Winter 24-hour average TSS, VSS (organic particulate) and ISS (inorganic particulate) influent concentration. One day of measurement is repeated for 7 days in the dynamic simulation. The model input is the measured ISS concentration. VSS is calculated based on (constant) fractions determined in the influent specification. TSS is modelled as the sum of ISS and VSS.

4.9 pH influent measurements - Winter 2022

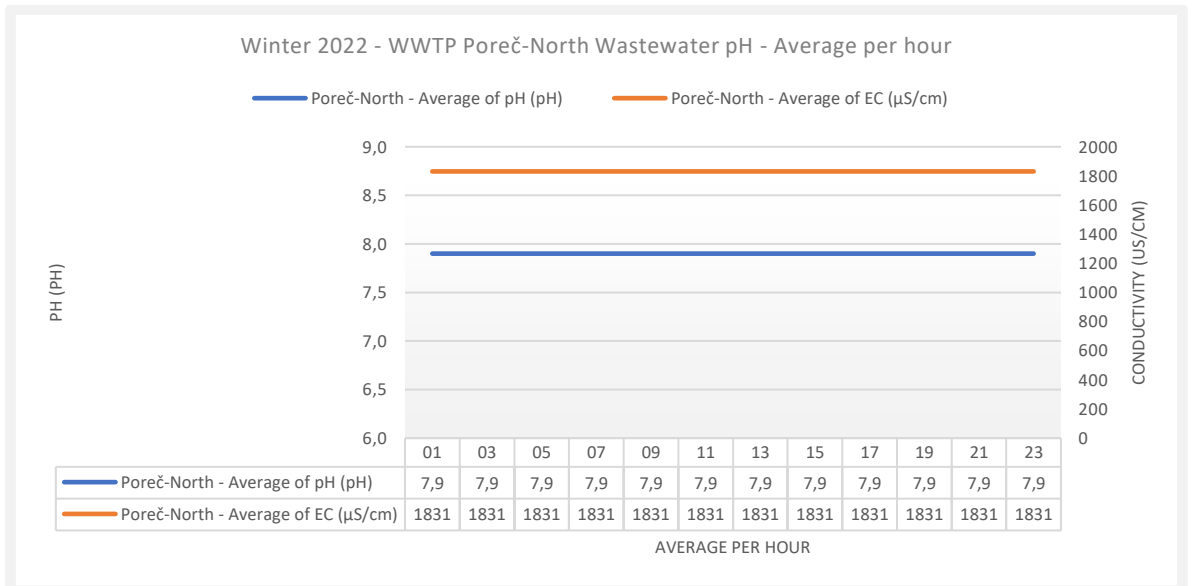

Figure 19. Winter 2022 - WWTP Poreč-North 24-hour average pH influent measurement.



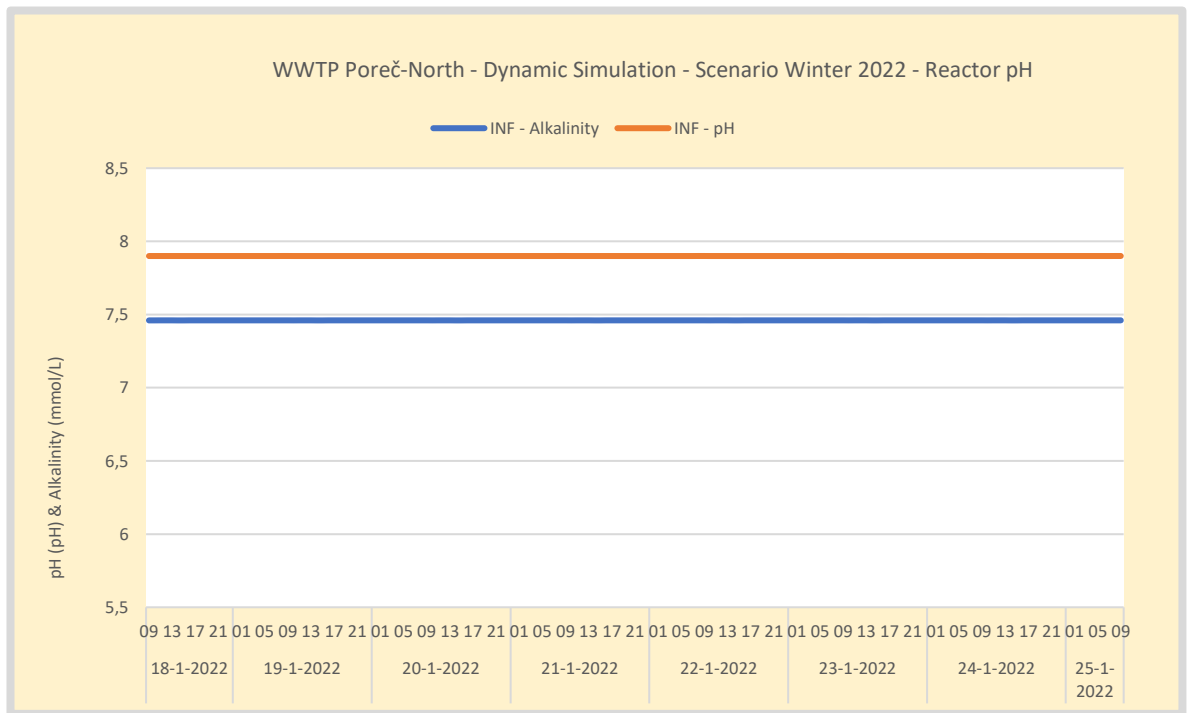

Figure 20. Dynamic Simulation – WWTP Poreč-North – Winter 24-hour average influent pH measurement. pH is a dynamic model input. The alkalinity of wastewater is estimated as a constant obtained from Poreč drinking water quality.



5 Influent loading profiles

5.1 Average influent loads

Daily average influent loads are presented in the graph below. The scale (0-100%) represents the total influent (total Poreč area) and the relative influent fractions treated by each WWTP.

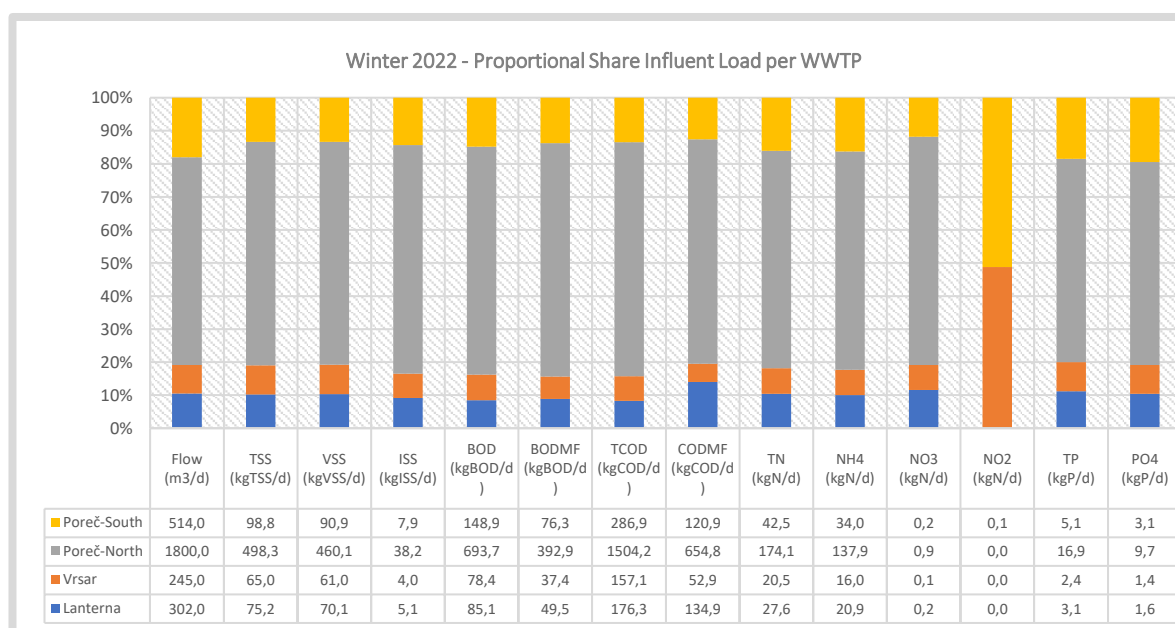

Figure 21. Winter 2022 - Proportional Share Influent Load per WWTP.

5.2 Influent COD 24-hour dynamic loading profile

The loading profile typically follows the flow profile with exception for periods where concentration peaks occur. The combined COD wastewater load for the Poreč area during the winter of 2022 is shown in the figures below. COD is partly particulate material and is transported more slowly through the sewer than soluble compounds. This effect is increased at low flow conditions. Compared to TN, the morning COD peak typically is lower and has a more gradual loading pattern over the day. The measured COD loading profile is typical for domestic source.



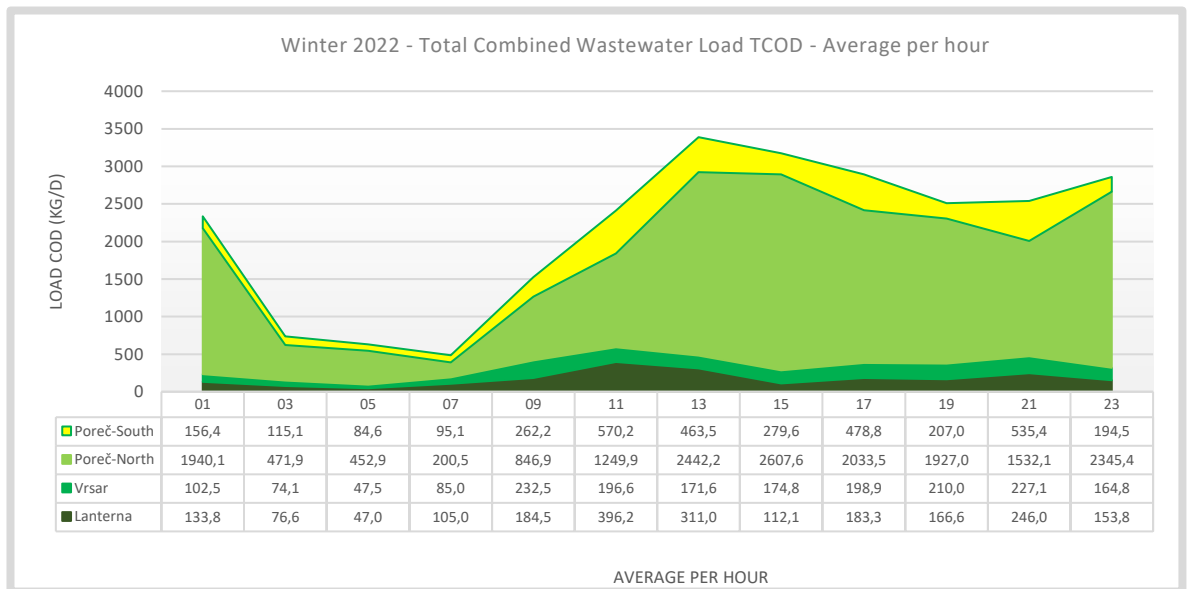

Figure 22. Winter 2022 - Sum of all WWTP's. Hourly average influent TCOD loads based on 1 measurement day, dry weather conditions.

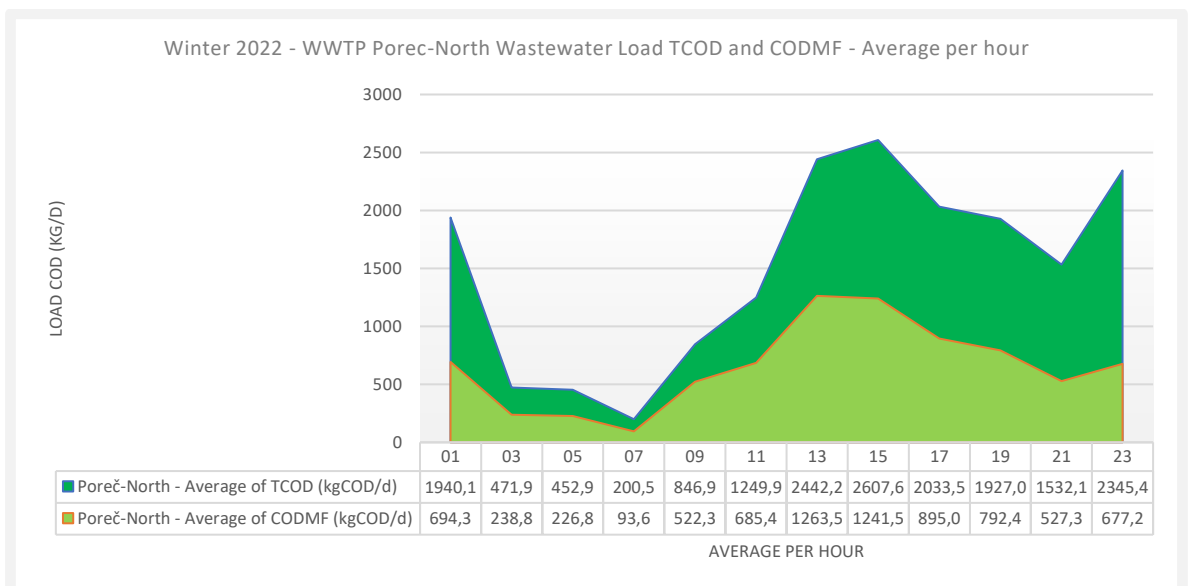

Figure 23. Winter 2022 - WWTP Poreč-North hourly average dry weather influent loads of total and filtered COD.

5.3 Influent Nitrogen 24-hour dynamic loading profile

The total nitrogen (TN) loading is presented in the graphs below. The data shows a typical domestical source. A large fraction of TN is soluble ammonium which is easily transported in the sewer. This typically results in a high peak of ammonium in the morning between 11:00 and 13:00, depending on the flow and sewer residence time. Ammonium peaks result in a high oxygen demand at the WWTP because of the nitrification process. Under peak conditions, especially when the wastewater is warm, aeration can be come limiting. Small presence of nitrate is measured in the sewage. Appearance of nitrate in closed sewers could be caused by nitrate rich groundwater infiltration.



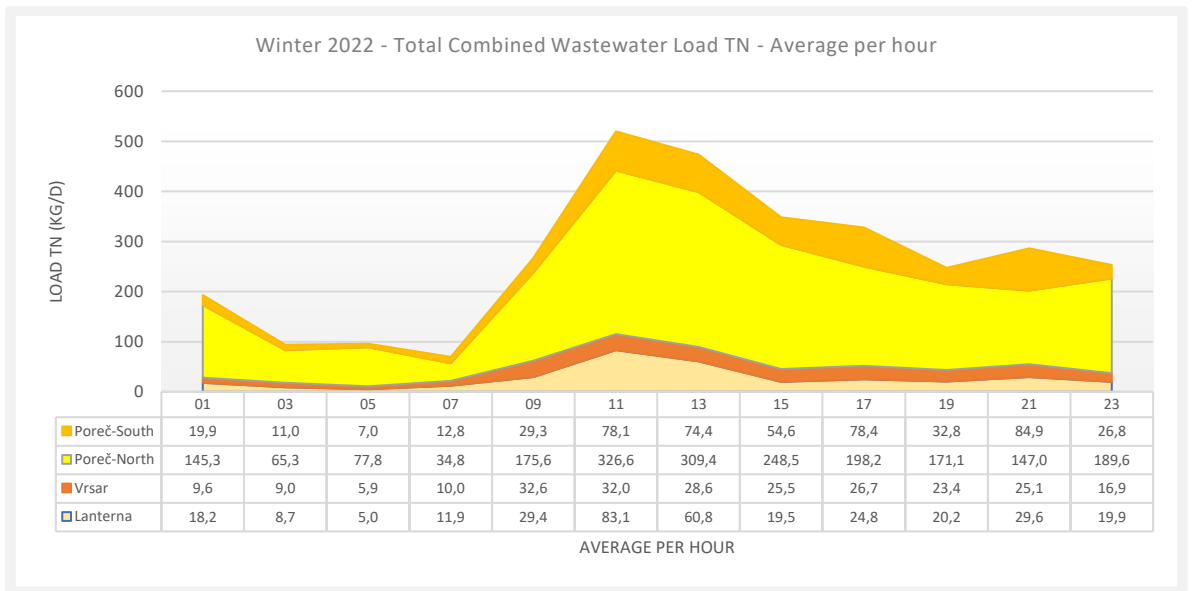

Figure 24. Winter 2022 - Sum of all WWTP's. Hourly average influent TN loads based on 1 measurement day under dry weather.

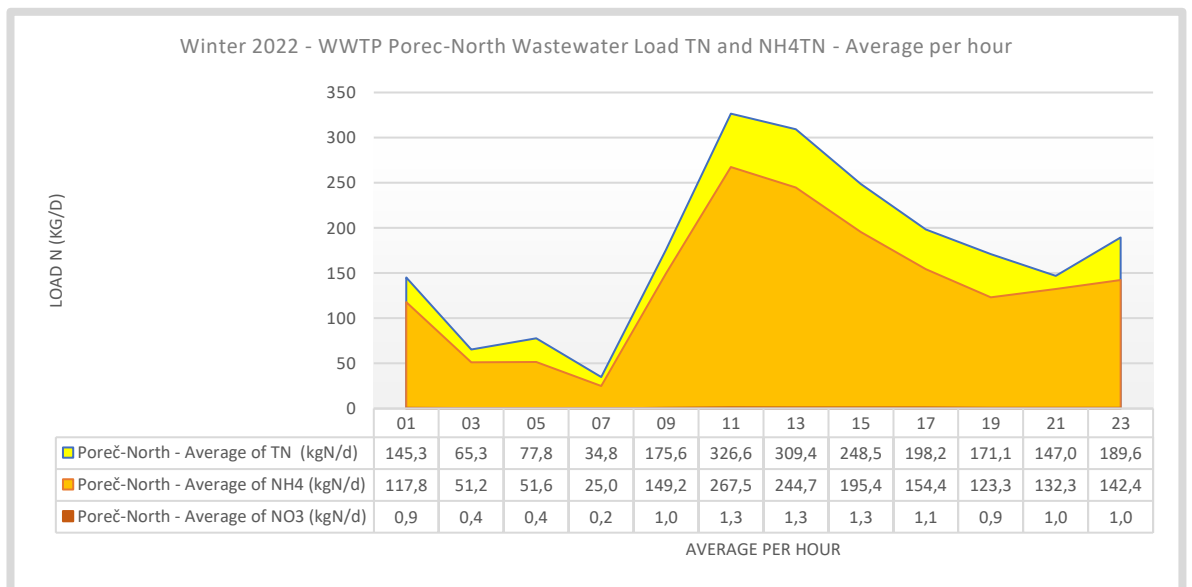

Figure 25. Winter 2022 - WWTP Poreč-North hourly average dry weather influent loads TN, NH4 and NO3, based on 1 measurement day under dry weather conditions.

5.4 Influent Phosphorus 24-hour dynamic loading profile

The phosphorus loading is presented in the graphs below. Phosphorus consists of a soluble ortho-phosphate fraction which is easily transported in the sewer system. Typically, a smaller fraction is related to particulate organic material (particulate COD).

Orthophosphate originates mostly from domestic source in the form of urine. Phosphate often resembles the ammonium profile, peaking between 11:00 and 13:00.



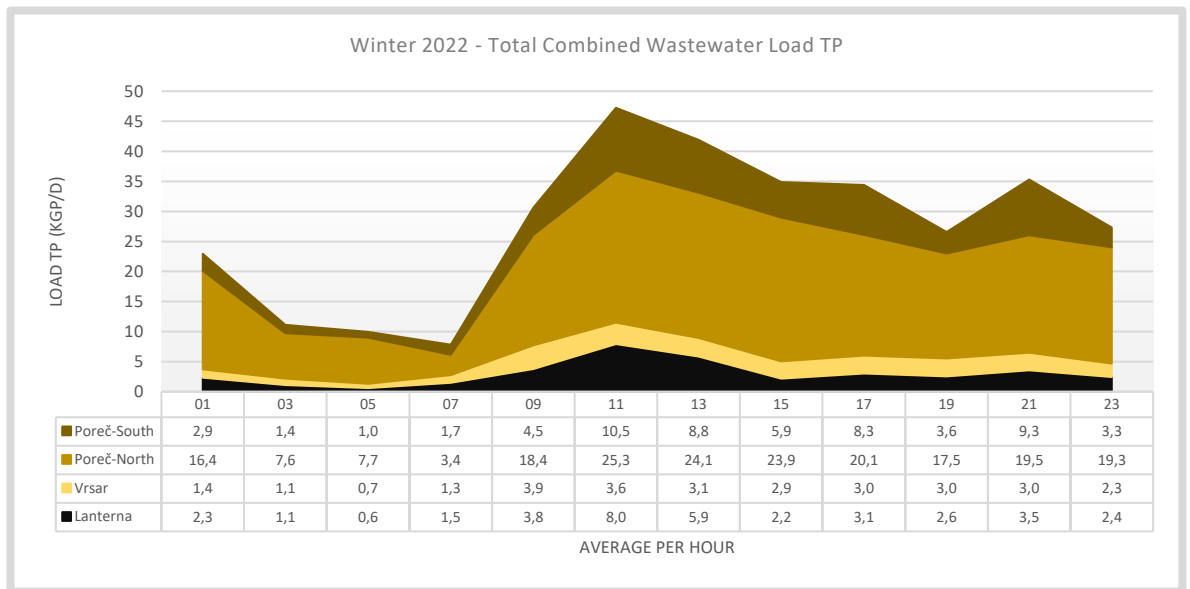

Figure 26. Winter 2022 - Sum of all WWTP's. Hourly average influent TP load based on 1 measurement day, dry weather conditions.

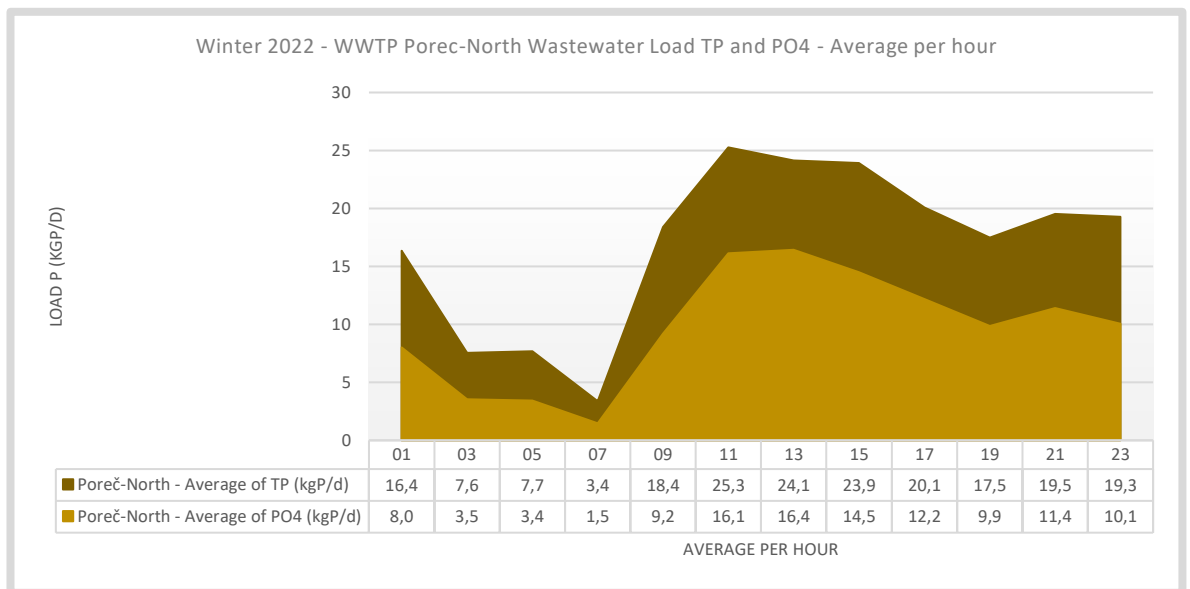

Figure 27. Winter 2022 - WWTP Poreč-North hourly average influent loads TP and PO4, based on 1 measurement day, dry weather conditions.

5.5 Influent Total Suspended Solids 24-hour dynamic loading profile

The loading of particulate material (total suspended solids) is presented in the graphs below. Particulate material typically has a longer transportation time in the sewer. Solid materials will settle in the sewer, especially during dry weather and low nightly flow. Therefore, at low flow conditions, TSS concentration measurements usually are underestimated by 15-25%. During peak flow or rain events, the settled TSS fraction is stirred up and transported to the WWTP. Under these conditions, concentration measurements are generally overestimated. As a result, during low season and low flow conditions, usually only one TSS peak is measured during the day, while during high



season two peaks are measured: One in the morning and one in the evening coinciding with the flow dynamics. TSS consists largely of organic material (volatile suspended solids or VSS). The inorganic fraction (ISS) is typically 6-9%. TSS is typically organic material from domestic source and solids collected from the pavement during rain events. Typically, half of the domestic TSS source is cellulose originating from toilet paper. Industrial and agricultural TSS usually are fibers with a low biodegradability.

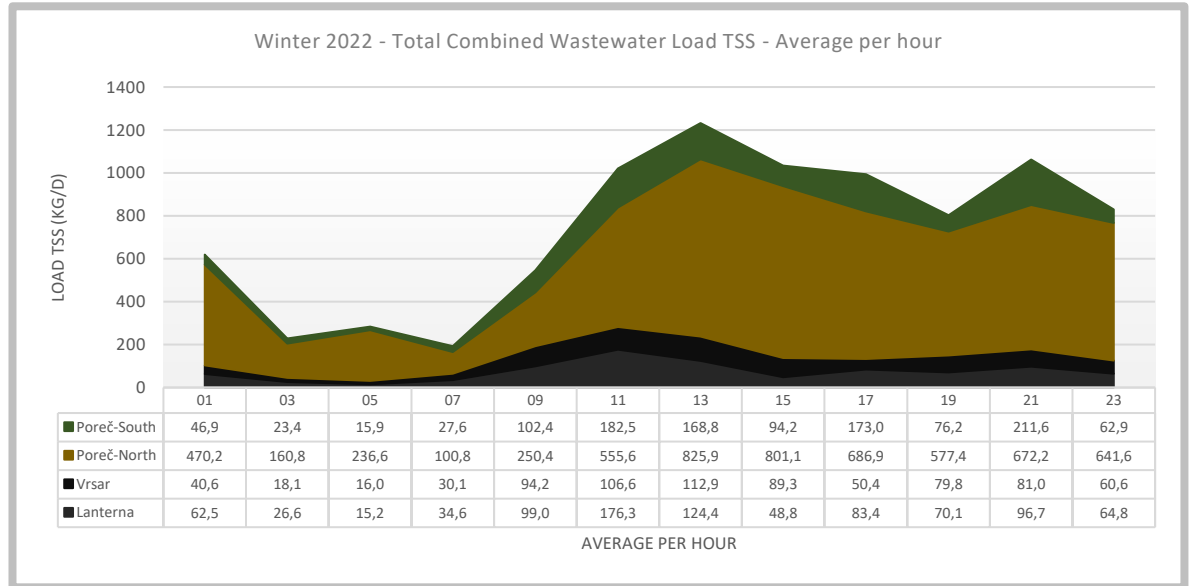

Figure 28. Winter 2022 - Sum of all WWTP's. Hourly average influent TSS load based on 1 measurement day, dry weather conditions.

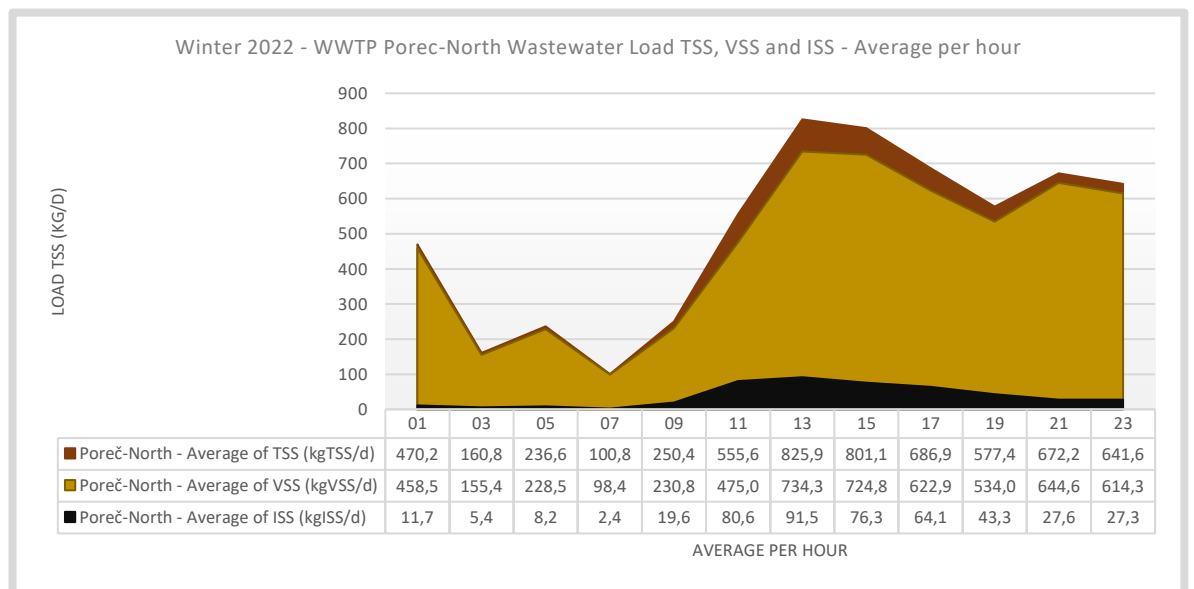

Figure 29. Winter 2022 - WWTP Poreč-North hourly average influent loads TSS, VSS and ISS, based on 1 measurement day, dry weather conditions.



6 Influent specification model

6.1 Determining fractions of influent concentrations

Influent is evaluated based on the BioWin influent specification model, also called influent characterization. This model makes separate calculations to be used as an input for the BioWin activated sludge model. The model is presented in appendix 3. The BioWin influent specification model requires average influent measurement values as input and calculates a set of wastewater parameters presented in the table below. From total COD, N and P the model determines the fractions. For example, the fractions soluble, particulate, and colloidal, biodegradable, and inert and the nitrogen and phosphorus fractions of the different COD fractions. Note that all fractions in the table are in terms of COD. BioWin calculates the influent strength in terms of COD. BOD is fitted to the measured COD using the specification model presented in appendix 3.

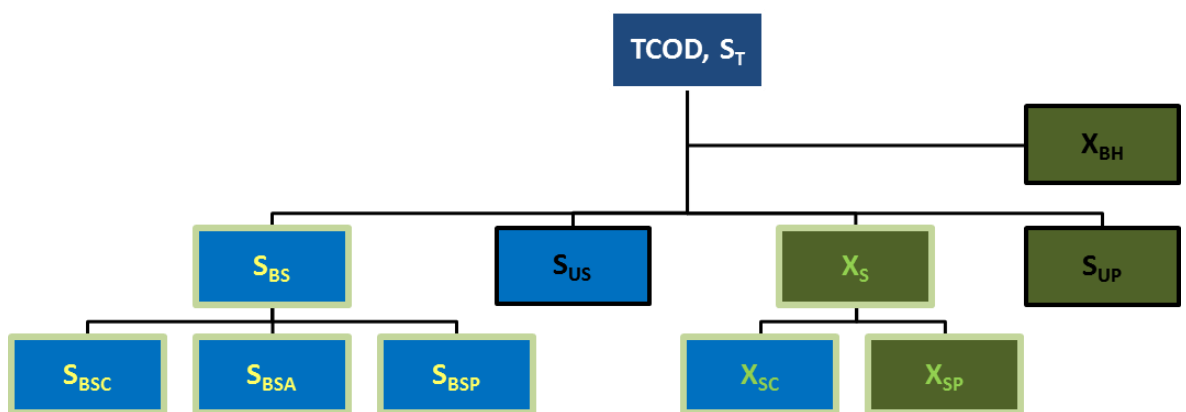

Figure 30. BioWin specification of COD fractions based on total COD in the influent. Blue is soluble (S) and (olive) green particulate or colloidal particulate (X). Green lined boxes are biodegradable and black lined boxes inert. Yellow text indicates readily biodegradable and green text slowly biodegradable.



Table 2. BioWin default influent fractions and calibrated values based on 2022 influent data. Technical note: Setting fractions to zero may result in simulation difficulties.

| WWTP Poreč-North - Winter 2022 Result Influent Specifier - Initial Input COD Influent Fractions | | | | |
|---|---|---------------------------------------|-------------------------|-------------------------|
| Name | Description | Unit | Raw Wastewater Defaults | Winter Calibrated Value |
| Fbs | Readily biodegradable (including Acetate) | [gCOD/g of total COD] | 0,160 | 0,397 |
| Fac | Acetate | [gCOD/g of readily biodegradable COD] | 0,150 | 0,219 |
| Fxsp | Non-colloidal slowly biodegradable | [gCOD/g of slowly degradable COD] | 0,750 | 0,709 |
| Fus | Unbiodegradable soluble | [gCOD/g of total COD] | 0,050 | 0,038 |
| Fup | Unbiodegradable particulate | [gCOD/g of total COD] | 0,130 | 0,170 |
| Fcel | Cellulose fraction of unbiodegradable particulate | [gCOD/gCOD] | 0,500 | 0,450 |
| Fna | Ammonia | [gNH ₃ -N/gTKN] | 0,660 | 0,792 |
| Fnox | Particulate ammonia organic nitrogen | [gN/g Organic N] | 0,500 | 0,500 |
| Fnus | Soluble unbiodegradable TKN | [gN/gTKN] | 0,020 | 0,001 |
| FupN | N:COD ratio for unbiodegradable part. COD | [gN/gCOD] | 0,070 | 0,070 |
| Fpo4 | Phosphate | [gPO ₄ -P/gTP] | 0,500 | 0,574 |
| FupP | P:COD ratio for unbiodegradable part. COD | [gP/gCOD] | 0,022 | 0,022 |
| Fsr | Reduced sulfur [H ₂ S] | [gS/gS] | 0,150 | 0,150 |
| FZbh | Ordinary heterotrophic COD fraction | [gCOD/g of total COD] | 0,020 | 0,020 |
| FZbm | Methylotrophic COD fraction | [gCOD/g of total COD] | 1,00E-04 | 1,00E-04 |
| FZao | Ammonia oxidizing COD fraction | [gCOD/g of total COD] | 1,00E-04 | 1,00E-04 |
| FZno | Nitrite oxidizing COD fraction | [gCOD/g of total COD] | 1,00E-04 | 1,00E-04 |
| FZaao | Anaerobic ammonia oxidizing COD fraction | [gCOD/g of total COD] | 1,00E-04 | 1,00E-04 |
| FZppa | Phosphorus accumulating COD fraction | [gCOD/g of total COD] | 1,00E-04 | 1,00E-04 |
| FZpa | Propionic acetogenic COD fraction | [gCOD/g of total COD] | 1,00E-04 | 1,00E-04 |
| FZam | Acetoclastic methanogenic COD fraction | [gCOD/g of total COD] | 1,00E-04 | 1,00E-04 |
| FZhm | Hydrogenotrophic methanogenic COD fraction | [gCOD/g of total COD] | 1,00E-04 | 1,00E-04 |
| FZso | Sulfur oxidizing COD fraction | [gCOD/g of total COD] | 1,00E-04 | 1,00E-04 |
| FZsrp a | Sulfur reducing propionic acetogenic COD fraction | [gCOD/g of total COD] | 1,00E-04 | 1,00E-04 |
| FZsra | Sulfur reducing acetotrophic COD fraction | [gCOD/g of total COD] | 1,00E-04 | 1,00E-04 |
| FZsrh | Sulfur reducing hydrogenotrophic COD fraction | [gCOD/g of total COD] | 1,00E-04 | 1,00E-04 |
| FZe | Endogenous products COD fraction | [gCOD/g of total COD] | 0,0000 | 0,0000 |

6.2 Results of the specification model

The table above presents the results of the influent specification model. The parameters are input values for BioWin. Input data for pH, Ca, Mg, and alkalinity are used to calculate pH and chemical precipitation reactions. Estimates of Ca, Mg, and alkalinity are made based on data from local drinking water quality measurements provided by the drinking water company. The unbiodegradable soluble COD and TKN in the influent is estimated based on measurement of effluent soluble COD and TKN. For systems with an SRT larger than 3 days typically 98% of effluent soluble COD is unbiodegradable (Fus, SI). Glass Filtered COD (COD_{GF}) is filtered over a glass fiber filter of 1,2 microns and typically is 40% of TCOD. Membrane Filtered COD (COD_{MF}) is flocculated, and membrane filtered over 0,45 microns and thereby the fraction COD_{MF} is always lower than COD_{GF} which contains some colloidal (particulate) material. BOD measurements are including the nitrification inhibitor ATU (therefore carbonaceous BOD). Volatile fatty acids are typically assumed to be 100% acetate. However also a smaller fraction of propionate may be present in raw sewage.



Table 3. Result of the BioWin influent specification model for all WWTP's.

| Influent measurements for BioWin Influent Characterization - Winter 2022 | | | | | | |
|--|--------------------------------------|------------------------|----------|-------|-------------|-------------|
| Main influent measurements | Notations | Unit | Lanterna | Vrsar | Poreč-North | Poreč-South |
| Flow | Q | m ³ /d | 302 | 245 | 1800 | 514 |
| Total COD | TCOD, ST | mgCOD/L | 584 | 641 | 836 | 558 |
| Total Kjeldahl Nitrogen | TKN | mgN/L | 91,4 | 83,5 | 96,7 | 82,7 |
| Total P | TP | mgP/L | 10,2 | 9,9 | 9,4 | 9,9 |
| Other influent measurements | Notations | Unit | Lanterna | Vrsar | Poreč-North | Poreč-South |
| Nitrate N | NO3-N, SNO3 | mgN/L | 0,5 | 0,6 | 0,5 | 0,4 |
| pH | pH | - | 8,0 | 8,1 | 7,9 | 8,2 |
| Alkalinity (CaCO ₃ equivalent) | Alk | mgCaCO ₃ /L | 373 | 373 | 373 | 373 |
| Calcium | Ca, Sca | mg/l | 80 | 80 | 80 | 80 |
| Magnesium | Mg, SMg | mg/l | 15 | 15 | 15 | 15 |
| Dissolved oxygen | DO, (SO ₂) | mgO ₂ /l | 0,1 | 0,1 | 0,1 | 0,1 |
| Additional measurements for modeling | Notations | Unit | Lanterna | Vrsar | Poreč-North | Poreč-South |
| Effluent filtered COD | CODS_EFF | mgCOD/L | 35 | 36 | 32 | 48 |
| Influent filtered COD (including colloidal) | CODGF_INF, CODS_INF | mgCOD/L | 279 | 270 | 455 | 294 |
| Influent FF COD (excluding colloidal) | CODMF_INF | mgCOD/L | 223 | 216 | 364 | 235 |
| Influent acetate | HAc, VFA, SA | mgCOD/L | 44,7 | 43,2 | 72,8 | 47,0 |
| Influent ammonia | NH ₄ -N, SNH ₄ | mgN/l | 69,3 | 65,5 | 76,6 | 66,1 |
| Influent ortho-phosphate | PO ₄ -P, SPO ₄ | mgP/l | 5,5 | 5,6 | 5,4 | 6,0 |
| Influent carbonaceous BOD ₅ | TCBOD, TBOD, BOD ₅ | mgO ₂ /l | 282 | 288 | 385 | 290 |
| Influent filtered cBOD ₅ | SCBOD, SBOD, BODS | mgO ₂ /l | 164 | 153 | 273 | 149 |
| Influent VSS | VSS | mgVSS/L | 232 | 249 | 281 | 186 |
| Influent TSS | TSS | mgTSS/L | 249 | 265 | 305 | 202 |
| Derived model fractions | Notations | Unit | Lanterna | Vrsar | Poreč-North | Poreč-South |
| Fraction unbiodegradable Soluble COD | Fus | - | #REF! | #REF! | #REF! | #REF! |
| Particulate COD non-colloidal | CODp, CODX | mgCOD/l | 305 | 371 | 381 | 264 |
| Readily biodegradable COD including VFA | Fbs | - | #REF! | #REF! | #REF! | #REF! |
| Acetate fraction of readily biodegradable COD (SBS) | Fac | - | #REF! | #REF! | #REF! | #REF! |
| fraction ammonia of TKN | Fna | - | 0,76 | 0,78 | 0,79 | 0,80 |
| fraction phosphate of TP | Fpo ₄ | - | 0,54 | 0,56 | 0,57 | 0,60 |
| TCOD/BOD ₅ , total COD over BOD ₅ ratio | TCOD/BOD ₅ | - | 2,07 | 2,23 | 2,17 | 1,93 |
| CODX/VSS, particulate (non-colloidal) COD/VSS ratio | Fcv | - | 1,31 | 1,49 | 1,35 | 1,42 |
| Inorganic suspended solids (ash fraction of TSS) | ISS | mg/l | 17 | 16 | 23 | 16 |

6.3 Conclusions

The measured influent data results in a well fitted specification model within acceptable range of parameter settings. Influent data is tested reliable and validated as wastewater of mainly domestic source applicable for WWTP modelling. The result of the specification model is a set of BioWin model input parameters and is part of the model calibration procedure which is further discussed in the following chapter. The specification model and calculation method are presented in appendix 3.



7 Model calibration and validation

7.1 Static calibration

The model is calibrated based on average 24-hour dynamic winter 2022 influent and effluent measurements. Model parameters are adjusted to reproduce the measured average effluent performance of COD, N and P. The parameter adjustments for calibration are presented in the table below. No stoichiometric parameters are adjusted. This indicates the model is valid. Some kinetic parameters are adjusted to finetune the model performance on the specific dataset and correct for approximations used in the simulation of operational conditions. Finetuning of kinetic parameters is allowed within acceptable margin and typically required for each new simulated condition.

Table 4. BioWin model calibration parameter adjustments.

| WWTP Poreč-North - 2022 - Calibrated parameters | | | |
|--|------------|------------|--|
| Parameter Name | BW Default | Calibrated | Affecting |
| Ordinary heterotrophic DO half sat. [mgO ₂ /L] | 0,15 | 0,9 | Simultaneous nitrification and denitrification |
| Ammonia oxidizing DO half sat. [mgO ₂ /L] | 0,25 | 0,1 | Reduces nitrification at low DO |
| Phosphorus accumulating DO half sat. [mgO ₂ /L] | 0,05 | 0,15 | Improves Nitrite oxidation at low DO |
| Anoxic growth factor OHO [-] | 0,5 | 1,0 | Adaptation to anoxic conditions |
| Anoxic growth factor PAO [-] | 0,33 | 1,0 | Adaptation to anoxic conditions |
| Particulate substrate COD:VSS ratio [mgCOD/mgVSS] | 1,6327 | 1,4 | Solids accumulation from influent |
| Particulate inert COD:VSS ratio [mgCOD/mgVSS] | 1,6 | 1,2 | Solids accumulation from influent |
| Anoxic P/PHA uptake [mgP/mgCOD] | 0,35 | 0,635 | Updated yield according to TUDP-model |
| P/Ac release ratio [mgP/mgCOD] | 0,51 | 0,53 | Updated yield according to TUDP-model |
| Max. spec. growth rate [1/d] | 0,7 | 1,0 | Reducing accumulation of NO ₂ |

7.2 Anoxic growth factors for OHO and PAO

This parameter represents the fraction of heterotrophic organisms that can grow under both aerobic and anoxic conditions. The parameter proportionally reduces the growth rate under anoxic conditions. Substrate and nutrient limitations may further reduce the growth rate. Anoxic growth factors are adjusted to fit the model on the measured denitrification and effluent nitrogen concentration. The growth factors typically are increased for WWTP's designed with pre-denitrification where biomass is adapted to grow under full anoxic conditions (this in contrary to simultaneous nitrification and denitrification often observed in carousel type processes). By increasing the growth factor, a larger fraction of heterotrophic biomass (PAO and OHO) will have denitrifying capacity. In systems without



pre-denitrification these factors are usually set to the lower (default) value. The applied model adjustments are well within the acceptable range and do not affect the model reliability. These parameters also can change because of operation (e.g., applied anoxic recycle flow rate).

7.3 DO half saturation

The DO half saturation is a kinetic parameter determining the sensitivity for oxygen. It is adjusted to compensate for partial unaerated zones or unaerated periods which are the result of the oxygen control settings. By increasing the DO half saturation for denitrification, more simultaneous nitrification and denitrification (SND) will occur under low DO conditions. The parameter adjustment simulates the effect of partial aerated tanks. Under normal settings nitrite (NO₂) is formed in the model. Most likely as result of the simplified oxygen modeling because no nitrate is measured in the effluent. To compensate for this, the DO half saturation for nitrification is decreased to finetune the formation of nitrite, and the growth rate is increased to reduce effluent nitrate in the model. This has no significant effect on the model reliability and is mainly applied for fine tuning effluent results. The DO half saturation for nitrification is increased to reduce the nitrification rate at low DO concentration. This is done to reproduce the higher measured effluent ammonium concentration. Bacteria adjust to the operated DO conditions. This parameter therefore will change during operation and needs fine tuning for each simulated period. It is also possible the system is still adapting its kinetic sensitivity after its start-up and therefore not (yet) in steady state.

7.4 Particulate influent COD/VSS ratio

These parameters are the result of the influent specification calculation (appendix 3). The COD/VSS ratio determines how much solids accumulate in the WWTP and how much is biodegraded. The adjustments are directly derived from the applied influent measurements and well within the acceptable range and do not affect the model reliability.

Table 5. BioWin model calibration – Results model and measured effluent.

| WWTP Poreč-North - Scenario Winter 2022 - Result static calibration | | | |
|---|-------|---------------|-----------------|
| Attribute | Unit | EFF Simulated | EFF-measurement |
| COD - Total | mg/L | 42,2 | 47,1 |
| BOD - Total Carbonaceous | mg/L | 1,3 | 15,5 |
| N - Total N | mgN/L | 5,7 | 4,6 |
| N - Ammonia | mgN/L | 2,9 | 2,4 |
| N - Nitrate | mgN/L | 1,3 | 0,7 |
| P - Total P | mgP/L | 0,3 | 0,7 |
| Total suspended solids | mg/L | 0,0 | 0,0 |



7.5 Parameters PAO updated to TUDP-model

In BioWin the parameter for Anoxic P/PHA uptake and P/Ac release ratio are updated to the published TUDP-model. It is found that the anoxic performance of PAO's is less conservative than assumed in the default BioWin parameter settings. The PAO parameters are updated according to the latest research.

7.6 Calibration results and discussion

In the table below, the results of the model and the effluent measurements are compared. The model predicts the effluent within a reasonable range. In the calibration procedure the model is fitted primarily to NH₄ by adjusting the aeration control, and it is attempted to find the most optimal overall dynamic fit with the least parameter adjustment required. There are however some small deviations between the measurements and model results which are here discussed. Typically, measurements have a margin of error and show a spread as the result of small errors. However, measured and modelled effluent BOD shows a consistent deviation and is not predicted accurately. In general BOD is not a very reliable measurement especially in the low concentration range. Moreover, high soluble BOD in the effluent is unlikely for systems with sufficient aerobic SRT, which is the case for this WWTP (table 9). Therefore, it is assumed the measured BOD is overestimated (and consequently also total COD). Or the sample may be contaminated. The concentration values of NH₄, NO₃ and NO₂ are reasonably predicted taking in account these concentrations vary depending on the operation and time of day. Effluent NH₄, NO₃ and NO₂ are strongly dependent on the applied aeration and recirculation controls. Operational data was not available, and these controls are estimated in the model. This may also explain the (slight) formation of NO₂ in the model which also is consistently overestimated compared to the measurements, which generally are zero. Most likely NO₂ is not measured accurately for it is complicated to preserve and store samples properly and NO₂ quickly can convert before being measured. Considering the relatively high measured NH₄ some NO₂ is expected to be formed. This is supported by TN which does not add up with other measured nitrogen components. This may indicate a measurement error. As the result of a model artifact TN in the model is underestimated; Filtered COD has no individual parameter to set the nitrogen fraction. In the MBR filtered COD is the only effluent COD fraction and this also partly can explain the (small) gap between measured and modeled TN.



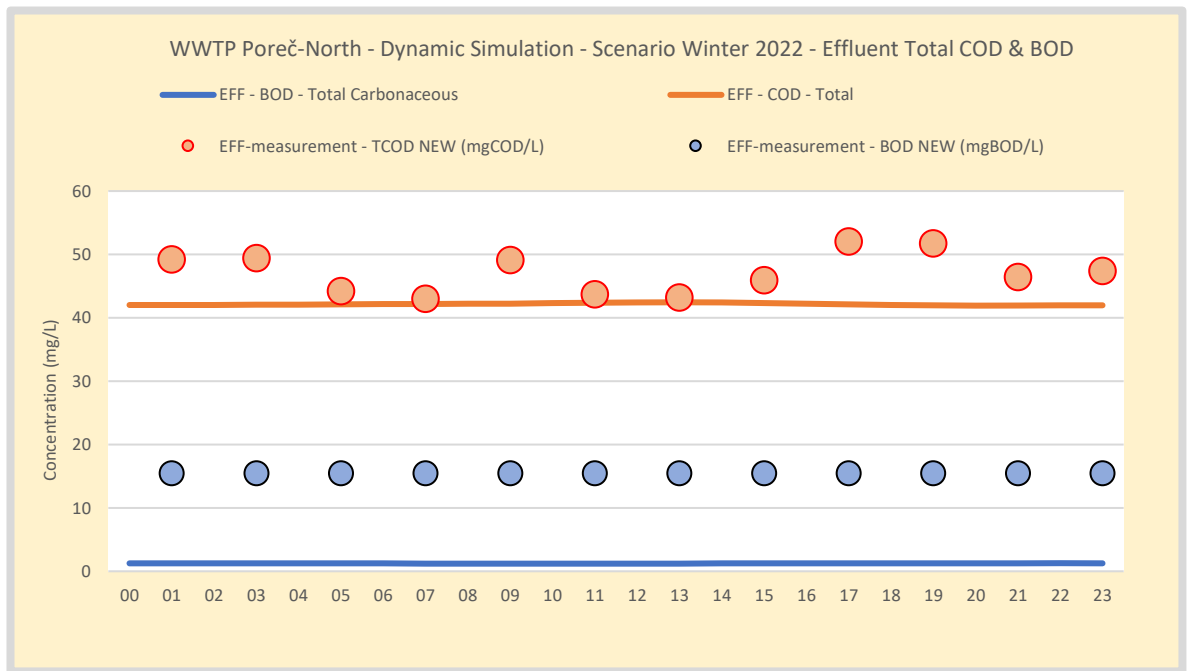

Figure 31. Winter 2022 – WWTP Poreč-North – Model validation based on 24-hour dynamic effluent COD and BOD data. For all measured effluent results the model underpredicts measured effluent BOD. Typical effluent BOD for systems operated at SRT > 3 days BOD is below 3 mg/L. The BOD measurements are likely unreliable.

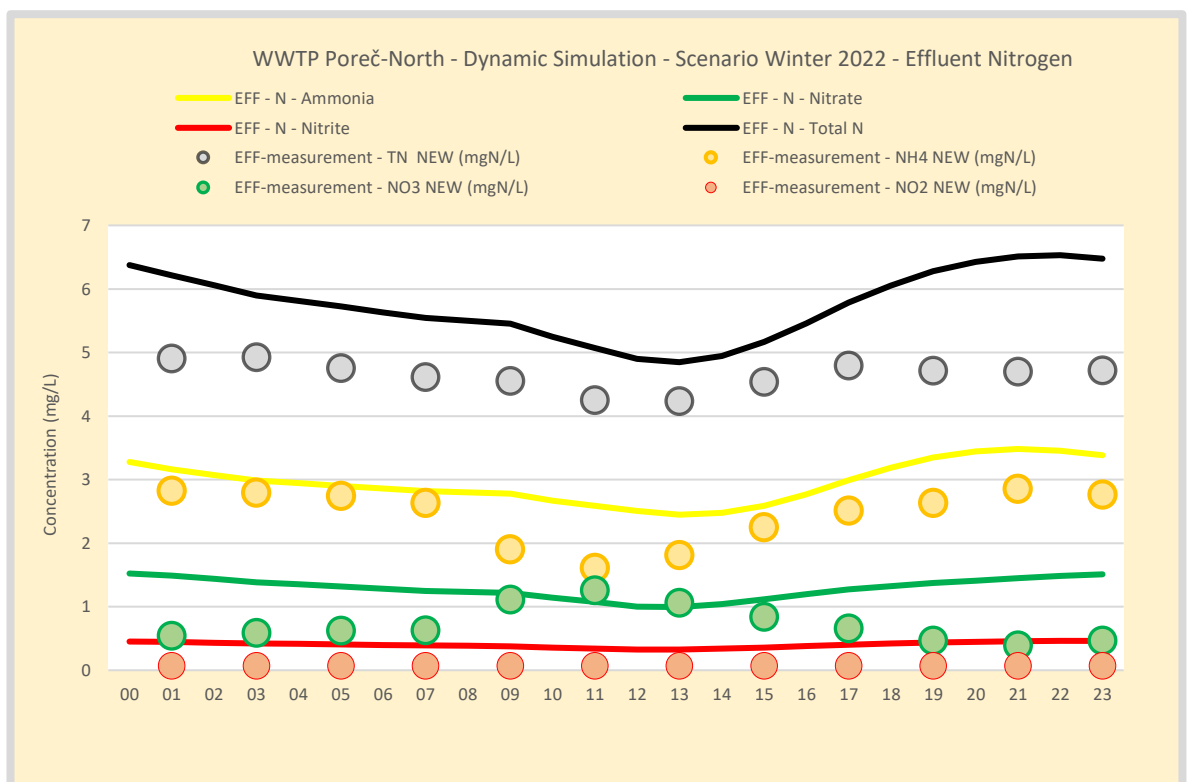

Figure 32. Winter 2022 – WWTP Poreč-North – Model validation based on 24-hour dynamic effluent TN, NH4 and NO3 data. The model is fitted to the effluent NH4 concentration. In the model 100% of effluent is buffered in the storage tank and variation in effluent TN is not well simulated. Formation of NO2 in the model is overestimated.



7.7 Model validation

The model is validated based on the presented calibration results; No stoichiometric or other critical parameters are adjusted to reproduce measured conditions. This indicates the model is valid and suited to simulate (dynamic) operational conditions and valid to be used for extrapolation to (future) load conditions (as is done in report 6 and 7). Validation is supported by dynamic model results. In the figures above the dynamic effluent performance is plotted against the measurements. The effluent is measured coming from the effluent buffer and is reasonably well reproduced by the model.

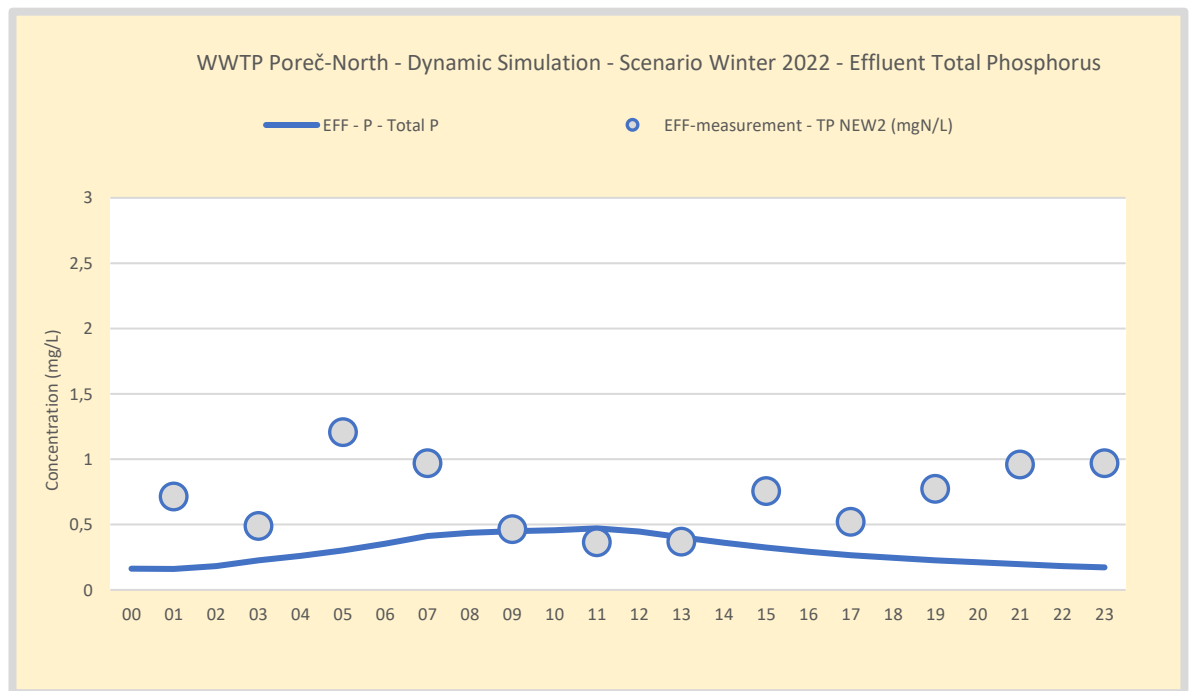

Figure 33. Winter 2022 – WWTP Poreč-North – Model validation based on 24-hour dynamic effluent TP.

7.8 Conclusion dynamic simulations

The WWTP result of the 2022 calibrated model (appendix 4) is largely identical to the results of the 2019 7-day dynamic winter simulation presented in report 7. The effluent concentration is simulated within the projected effluent limits. Due to operational differences of aeration, SRT, and internal recycles, operational hour to hour effluent results can differ considerably. However, the overall performance of COD, N and P-removal is largely identical for both the 2019 and 2022 models. This is explained by the minor parameter adjustments required to simulate both conditions. This indicates the model is well developed, has no gross shortcomings, and is tested valid for application in this research project.

7.9 Conclusions

- The model is calibrated based on the provided operational data.
- Parameters are all adjusted within the typical and acceptable range.
- No stoichiometric parameters are adjusted.



- All adjustments are used to fit the model to specific operational conditions and typically required for each performed simulation study.
- Based on the presented calibration results the model is validated for interpolation to study operational dynamics and extrapolation for scenario analysis.
- Additional validation is provided by the dynamic simulation.
- The 2019 and 2022 calibrated model results are in accordance.
- The model is tested valid for use in this research project.



8 Conclusions and recommendations

8.1 General conclusions

- The model is tested successfully on an independent data set and reproduced all data without significant adjustments.
- The model is tested reliable and validated for use for operational and scenario evaluation.
- The above conclusions apply to all presented results, under which previous WWTP modelling reports published in this series, which have used the here validated model.

8.2 Summary of technical conclusions

- Influent dry weather flow data measured in the winter of 2019 and 2022 are comparable.
- There is similarity in the minimum and maximum flow data as well as the flow distribution pattern over the day on an hourly basis.
- The measured profile is successfully used in the calibration study to validate the model performance.
- The measured influent data results in a well fitted model within acceptable range of parameter settings.
- Some measurements are inconsistent and corrected based on typical influent fractions.
- The total influent data set is tested reliable and validated as wastewater of mainly domestic source useful for WWTP modelling.
- The result of the specification model is used in the model calibration procedure.
- The model is calibrated based on the provided operational data.
- Parameters are all adjusted within the typical and acceptable range.
- No stoichiometric parameters needed to be adjusted.
- All adjustments are used to fit the model to specific operational conditions and typically required for each performed simulation study.
- Based on the calibration results the model is validated for interpolation, to study operational dynamics and for extrapolation and future scenario analysis.
- Additional model validation is provided by dynamic simulations.
- The 2019 and 2022 calibrated model results are in accordance.
- The model is tested valid for use in this research project.

8.3 Recommendations

It is recommended to proceed with final development of the scenario analysis and sea water modelling taking in account the presented conclusions.



Appendix 1. Influent Concentrations Winter 2022

| Winter 2022 - Average Concentrations; Time Average and Flow Proportional | | | | |
|--|----------|-------|-------------|-------------|
| | Lanterna | Vrsar | Poreč-North | Poreč-South |
| TSS | | | | |
| (mgTSS/L) - Flow Proportional | 249,0 | 265,2 | 276,8 | 192,2 |
| VSS | | | | |
| (mgVSS/L) - Flow Proportional | 232,2 | 248,8 | 255,6 | 176,8 |
| ISS | | | | |
| (mgISS/L) - Flow Proportional | 16,8 | 16,4 | 21,2 | 15,3 |
| BOD | | | | |
| (mgBOD/L) - Flow proportional | 281,8 | 319,8 | 385,4 | 289,7 |
| BODMF | | | | |
| (mgBOD/L) - Flow proportional | 163,9 | 152,6 | 218,3 | 148,5 |
| TCOD | | | | |
| (mgCOD/L) - Flow Proportional | 583,9 | 641,3 | 835,7 | 558,1 |
| CODMF | | | | |
| (mgCOD/L) - Flow Proportional | 446,5 | 216,0 | 363,8 | 235,2 |
| TN | | | | |
| (mgN/L) - Flow Proportional | 91,4 | 83,5 | 96,7 | 82,7 |
| NH4 | | | | |
| (mgN/L) - Flow Proportional | 69,3 | 65,5 | 76,6 | 66,1 |
| NO3 | | | | |
| (mgN/L) - Flow Proportional | 0,5 | 0,4 | 0,5 | 0,3 |
| NO2 | | | | |
| (mgN/L) - Flow Proportional | 0,0 | 0,2 | 0,0 | 0,1 |
| TP | | | | |
| (mgP/L) - Flow Proportional | 10,2 | 9,9 | 9,4 | 9,9 |
| PO4 | | | | |
| (mgP/L) - Flow Proportional | 5,5 | 5,6 | 5,4 | 6,0 |
| pH (-) - Flow proportional | 8,0 | 8,1 | 7,9 | 8,2 |
| TSS | | | | |
| (mgTSS/L) - Time Average | 254,3 | 256,3 | 273,3 | 185,9 |
| VSS | | | | |
| (mgVSS/L) - Time Average | 238,6 | 241,0 | 255,4 | 168,5 |
| ISS | | | | |
| (mgISS/L) - Time Average | 15,8 | 15,3 | 18,0 | 17,3 |
| BOD | | | | |
| (mgBOD/L) - Time Average | 281,8 | 319,8 | 385,4 | 289,7 |
| BODMF | | | | |
| (mgBOD/L) - Time Average | 163,9 | 152,6 | 218,3 | 148,5 |
| TCOD | | | | |
| (mgCOD/L) - Time Average | 624,3 | 652,9 | 796,4 | 599,0 |
| CODMF | | | | |
| (mgCOD/L) - Time Average | 465,3 | 219,9 | 347,1 | 235,9 |
| TN | | | | |
| (mgN/L) - Time Average | 86,5 | 82,0 | 94,5 | 80,2 |
| NH4 | | | | |
| (mgN/L) - Time Average | 68,3 | 64,1 | 73,6 | 64,6 |
| NO3 | | | | |
| (mgN/L) - Time Average | 0,5 | 0,4 | 0,5 | 0,3 |
| NO2 | | | | |
| (mgN/L) - Time Average | 0,0 | 0,2 | 0,0 | 0,1 |
| TP | | | | |
| (mgP/L) - Time Average | 10,2 | 9,9 | 9,4 | 9,9 |
| PO4 | | | | |
| (mgP/L) - Time Average | 5,6 | 5,6 | 5,1 | 5,9 |
| pH (-) - Time Average | 8,0 | 8,1 | 7,9 | 8,2 |



Appendix 2. Influent Load Winter 2022

| Winter 2022 - Average Influent Loads per WWTP | | | | |
|---|----------|-------|-------------|-------------|
| | Lanterna | Vrsar | Poreč-North | Poreč-South |
| Flow (m ³ /d) | 302,0 | 245,0 | 1800,0 | 514,0 |
| TSS (kgTSS/d) | 75,2 | 65,0 | 498,3 | 98,8 |
| VSS (kgVSS/d) | 70,1 | 61,0 | 460,1 | 90,9 |
| ISS (kgISS/d) | 5,1 | 4,0 | 38,2 | 7,9 |
| BOD (kgBOD/d) | 85,1 | 78,4 | 693,7 | 148,9 |
| BODMF (kgBOD/d) | 49,5 | 37,4 | 392,9 | 76,3 |
| TCOD (kgCOD/d) | 176,3 | 157,1 | 1504,2 | 286,9 |
| CODMF (kgCOD/d) | 134,9 | 52,9 | 654,8 | 120,9 |
| TN (kgN/d) | 27,6 | 20,5 | 174,1 | 42,5 |
| NH ₄ (kgN/d) | 20,9 | 16,0 | 137,9 | 34,0 |
| NO ₃ (kgN/d) | 0,2 | 0,1 | 0,9 | 0,2 |
| NO ₂ (kgN/d) | 0,0 | 0,0 | 0,0 | 0,1 |
| TP (kgP/d) | 3,1 | 2,4 | 16,9 | 5,1 |
| PO ₄ (kgP/d) | 1,6 | 1,4 | 9,7 | 3,1 |



Appendix 3. BioWin Model Influent Specification

Results of the influent specification model

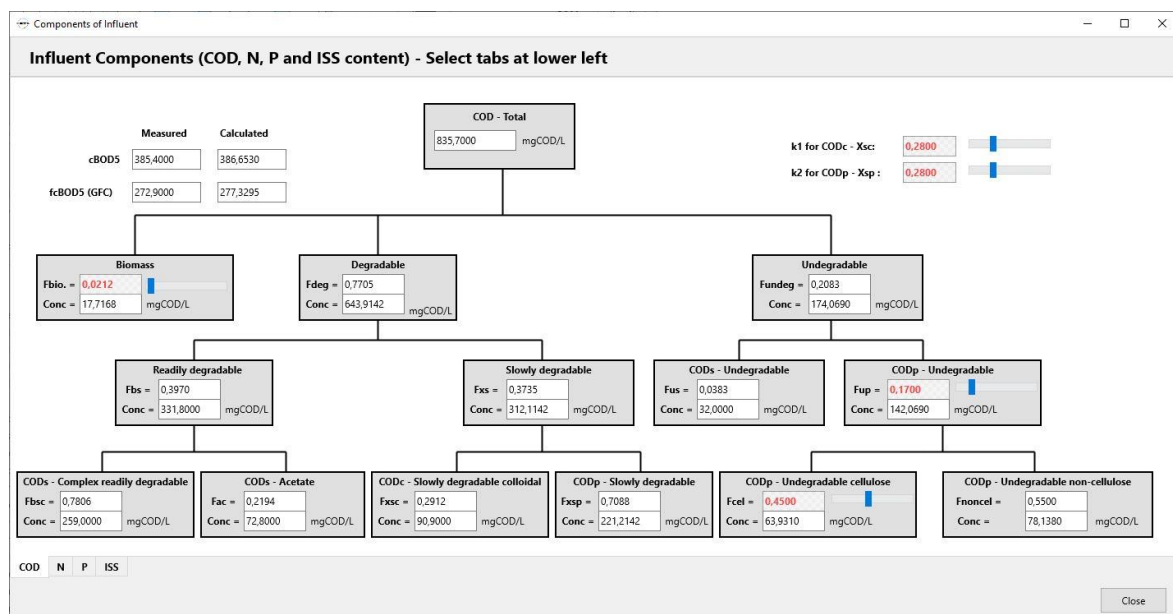

Influent Specifier - 2022 02 14 PONO Winter 2022 MYRrev001.ets

File Setting View Stoichiometry About

Input Measurements Adjust Fractions View Results Export to BioWin

| Fraction / Parameter Estimates | | | Fraction Calculation Results | | | |
|---------------------------------------|---------|----------|------------------------------|----------|------------|--------------|
| Name | Default | Estimate | Influent Values | Measured | Calculated | Match Status |
| COD Fractions | | | COD - Total | 835,7000 | 835,7000 | - |
| Fbs | 0,1600 | 0,3970 | COD - Particulate | 381,0000 | 381,0000 | Excellent |
| Fac | 0,1500 | 0,2194 | COD - Filtered | 454,7000 | 454,7000 | Excellent |
| Fxs | 0,6388 | 0,3735 | COD - FF | 363,8000 | 363,8000 | Excellent |
| Fxsp | 0,7500 | 0,7088 | BOD - Total Carbonaceous | 385,4000 | 386,6530 | Excellent |
| Fbiomass | 0,0212 | 0,0212 | BOD - Filtered Carbonaceoi | 272,9000 | 277,3295 | Excellent |
| Fus | 0,0500 | 0,0383 | VSS | 281,2000 | 281,2668 | Excellent |
| Fup | 0,1300 | 0,1700 | TSS | 304,5000 | 304,5668 | Excellent |
| Cellulose (Note...) | 0,5000 | 0,4500 | | | | |
| Non-Cellulose | 0,5000 | 0,5500 | | | | |
| COD : VSS | | | Influent CODp : VSS | 1,3549 | 1,3546 | Excellent |
| Particulate Biodegradable COD : VSS | 1,6327 | 1,4000 | Influent Total COD : cBOD | 2,1684 | 2,1614 | Excellent |
| Particulate Inert COD : VSS | 1,6000 | 1,2000 | VSS : TSS | 0,9235 | 0,9235 | Excellent |
| Cellulose COD : VSS | 1,4000 | 1,4000 | | | | |
| BOD Model Parameters (Note...) | | | | | | |
| k1 for CODc - Xsc | 0,5000 | 0,2800 | | | | |
| k2 for CODp - Xsp | 0,5000 | 0,2800 | | | | |



Influent Specifier - 2022 02 14 PONO Winter 2022 MYRrev001.ets

File Setting View Stoichiometry About

Input Measurements Adjust Fractions **3 View Results** 4 Export to BioWin

| COD/BOD Calculation Results | | P, N and ISS Calculation Results | |
|------------------------------------|----------|--|---------|
| Name | Value | Name | Value |
| COD Calculation Results | | P Calculation Results | |
| B - Z [mg/L] | 17,7168 | P in biomass [mgP/L] | 0,3898 |
| CODc - Xsc [mg/L] | 90,9000 | P - Particulate degradable [mgP/L] | 1,8828 |
| CODp - Xsp [mg/L] | 221,2142 | P - Particulate undegradable [mgP/L] | 1,7190 |
| CODp - (Xu + Xuc) [mg/L] | 142,0690 | P - Releasable stored polyP [mgP/L] | 0,0084 |
| CODs - Sa [mg/L] | 72,8000 | P - Soluble phosphate [mgP/L] | 5,4000 |
| CODs - Sc [mg/L] | 259,0000 | Measured Total P [mgP/L] | 9,4000 |
| CODs - Su [mg/L] | 32,0000 | | |
| | | N Calculation Results | |
| COD Total-check [mg/L] | 835,7000 | N in biomass [mgN/L] | 1,2402 |
| | | N - Ammonia [mgN/L] | 76,6000 |
| COD - Particulate [mg/L] | 381,0000 | N - Particulate degradable organic [mgN/L] | 5,7281 |
| COD - Slowly Biodegradable [mg/L] | 312,1142 | N - Particulate undegradable organic [mgN/ | 5,4697 |
| COD - Readily Biodegradable [mg/L] | 331,8000 | N - Soluble degradable organic [mgN/L] | 5,7281 |
| | | N - Soluble undegradable organic [mgN/L] | 1,9340 |
| Sol. COD fraction | 0,5441 | Measured TKN [mgN/L] | 96,7000 |
| | | ISS Calculation Results | |
| BOD Calculation Results | | ISS of Biomass [mgISS/L] | 1,4741 |
| BODrbcod [mg/L] | 236,4769 | ISS of Influent Inorganic SS [mgISS/L] | 20,8554 |
| BODxsc [mg/L] | 99,4189 | ISS of PolyP [mgISS/L] | 0,0232 |
| BODxsp [mg/L] | 40,8526 | ISS of Xsp [mgISS/L] | 0,9472 |
| BODhet [mg/L] | 9,9045 | Measured ISS [mgISS/L] | 23,3000 |
| BODtotal [mg/L] | 386,6530 | | |



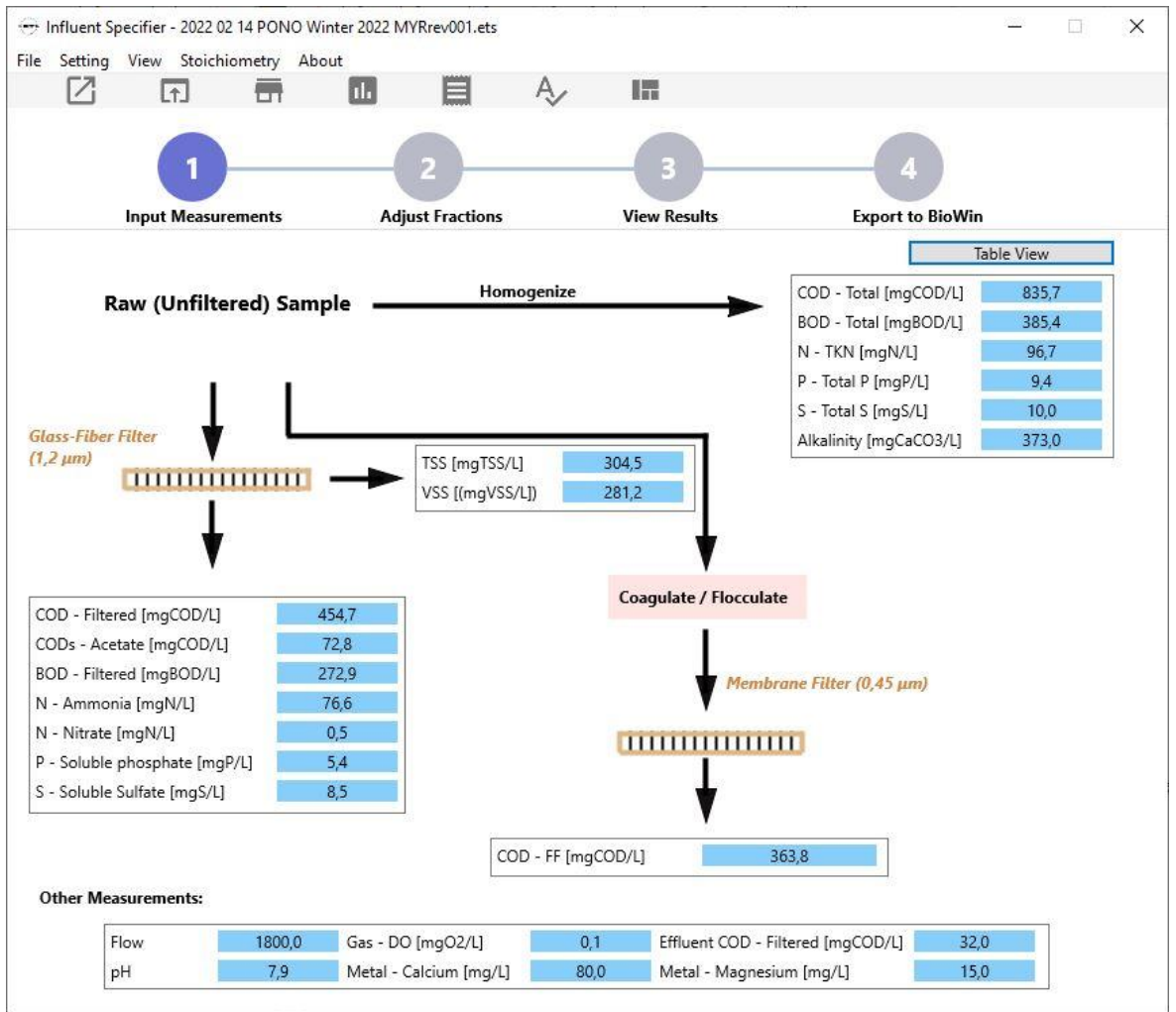

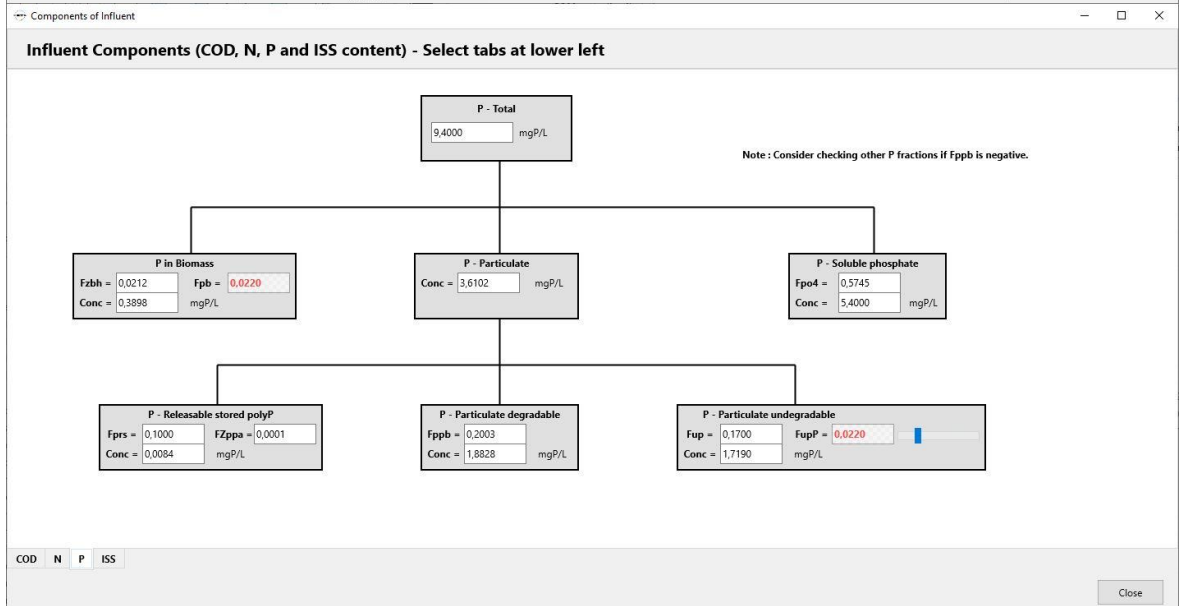
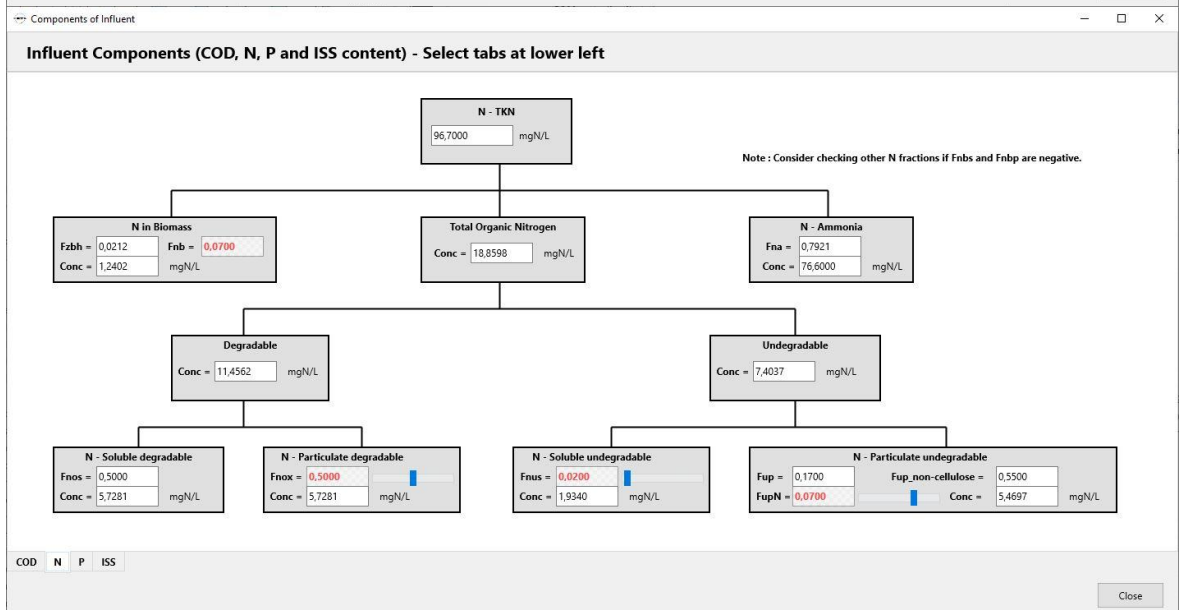
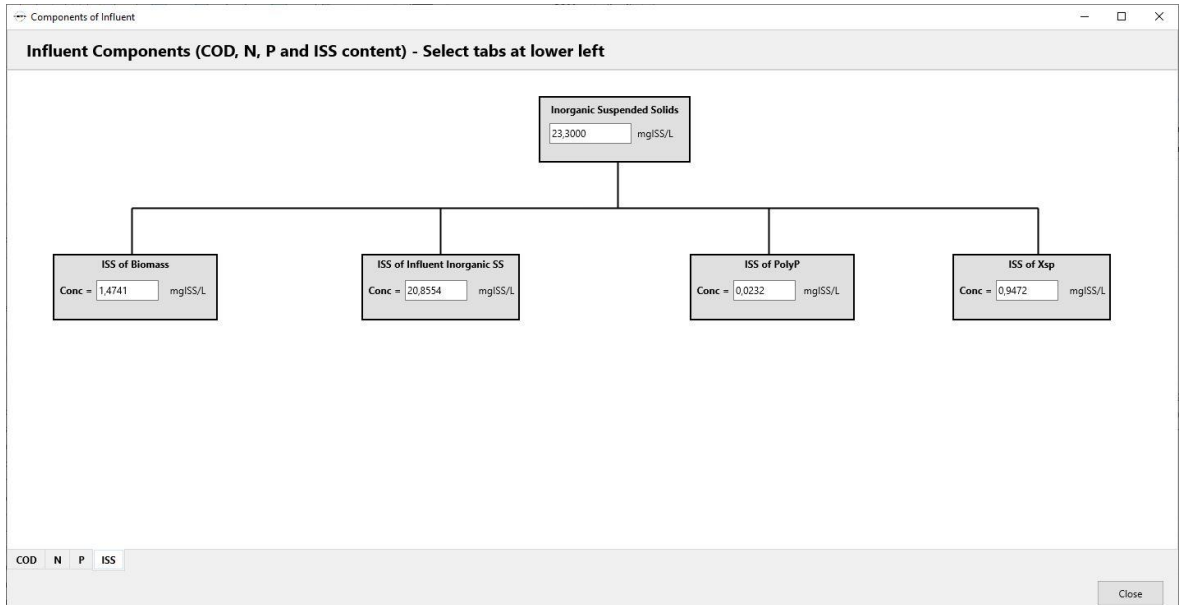

Presenting the BioWin influent specification model

The influent is divided in its fractions and used in the BioWin model calculations. Therefore, several influent fractions are introduced to facilitate the calculations in the model (Table 27, BW-influent tab). An overview of the fractions is presented below including relation to actual analytical measurements.

The influent unbiodegradable COD (S_{US}) for systems with a SRT > 3 days is based on the effluent measurement of soluble (glass filtered) COD according to:

$$S_{US} = COD_{S,EFF} = COD_{GF,EFF}$$

(Eq. 1)

The fraction unbiodegradable COD is calculated according to:

$$F_{US} = \frac{S_{US}}{TCOD} = \frac{COD_{GF,EFF}}{TCOD_{INF}}$$

(Eq. 2)

Soluble COD is including the colloidal and expressed as COD_S as the sum of all soluble model fractions. It can be measured from glass filtered COD according to:

$$COD_S = S_{BSA} + S_{BSP} + S_{BSC} + X_{SC} + S_{US} = COD_{GF,INF}$$

(Eq. 3)

Particulate (non-colloidal) COD (COD_p or COD_x) is the sum of particulate (non-colloidal) COD, particulate unbiodegradable COD and active biomass in the influent (X_{BH} is often assumed zero) given by:

$$COD_x = X_{SP} + S_{UP} + X_{BH} \approx X_{SP} + S_{UP}$$

(Eq. 4)

COD_x is calculated by subtracting the total COD and the soluble COD (COD_S) which is calculated based on the glass filtered COD according to:

$$COD_x = TCOD - COD_S = TCOD_{INF} - COD_{GF,INF}$$



(Eq. 5)

Soluble COD excluding the colloidal is expressed as COD_{MF} and measured from membrane filtering the COD according to:

$$COD_{MF} = S_{BSA} + S_{BSP} + S_{BSC} + S_{US} = COD_{MF,INF}$$

(Eq. 6)

The total soluble readily biodegradable COD (the total of acetate, propionate, and complex soluble COD but without slowly colloidal COD) is calculated from the measured micro filtered fraction COD_{MF} according to:

$$S_{BS} = S_{BSA} + S_{BSP} + S_{BSC} = COD_{MF} - S_{US} = COD_{MF,INF} - COD_{GF,EFF}$$

(Eq. 7)

The fraction of soluble readily biodegradable COD is given by:

$$F_{BS} = \frac{S_{BS}}{TCOD} = \frac{(S_{BSA} + S_{BSP} + S_{BSC})}{TCOD} = \frac{COD_{MF,INF} - COD_{GF,EFF}}{TCOD_{INF}}$$

(Eq. 8)

Influent acetate (+ propionate) is direct measured as VFA:

$$S_{BSA} + S_{BSP} = VFA_{INF}$$

(Eq. 9)

The fraction of readily biodegradable COD which is acetate is given by:

$$F_{AC} = \frac{S_{BSA}}{S_{BS}} = \frac{S_{BSA}}{(S_{BSA} + S_{BSP} + S_{BSC})} = \frac{VFA_{INF}}{COD_{MF,INF} - COD_{GF,EFF}}$$

(Eq. 10)



From the difference between the glass and membrane filtered COD, the colloidal fraction can be calculated according to:

$$X_{SC} = COD_S - COD_{MF} = COD_{GF,INF} - COD_{MF,INF}$$

(Eq. 11)

The last soluble parameter to be calculated is the complex soluble COD S_{BSC} calculated from the measurements according to:

$$S_{BSC} = COD_{MF} - S_{BSA} - S_{BSP} - S_{US} = COD_{MF,INF} - VFA_{INF} - COD_{GF,EFF}$$

(Eq. 12)

The total soluble (readily and slow colloidal) biodegradable COD (S_S) is the total of acetate, propionate, complex soluble COD and colloidal COD (influent methanol is assumed zero) given by:

$$S_S = S_{BSA} + S_{BSP} + S_{BSC} + X_{SC}$$

(Eq. 13)

And calculated according to:

$$S_S = COD_S - S_{US} = COD_{GF,INF} - COD_{GF,EFF}$$

(Eq. 14)

In the figure below biodegradable COD (S_S) is divided in fractions. BioWin notation of S_S should not be confused with IAWQ S_S which equals BioWin S_{BS} .



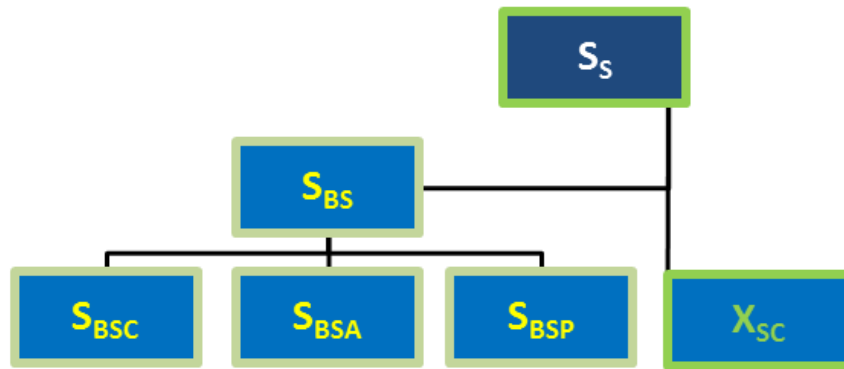

Figure 34. BioWin wastewater fractions of soluble biodegradable COD (S_s). The fraction is measured by glass filtering and includes all soluble and colloidal material. Blue fractions are soluble and (olive) green fractions (colloidal) particulate.

The last two influent fraction that need to be calculated are related to the solids: particulate biodegradable COD and unbiodegradable COD according to (Eq. 4):

$$COD_X = X_{SP} + S_{UP} + X_{BH} \approx X_{SP} + S_{UP}$$

These fractions are estimated from the BOD measurements in the influent as explained in the following sections of this chapter.

The BioWin influent tab the fraction of slowly biodegradable influent COD which is particulate is given by:

$$F_{XPS} = \frac{X_{SP}}{X_{SC} + X_{SP}}$$

(Eq. 15)

VSS is often calculated from ISS (Ash) measurement according to:

$$VSS = TSS - ISS$$

(Eq. 16)

The influent ratio of particulate (non-colloidal) COD to VSS is given by:

$$F_{CV} = \frac{COD_X}{VSS} = \frac{TCOD - COD_S}{VSS} = \frac{TCOD_{INF} - COD_{GF,INF}}{TSS - ISS}$$



(Eq. 17)

Ammonia is given by:

$$NH_3 = F_{NA} \times TKN$$

(Eq. 18)

Soluble unbiodegradable organic nitrogen is given by:

$$N_{US} = F_{NUS} \times TKN$$

(Eq. 19)

Nitrogen from organisms present in the influent is calculated by the sum of the products of the various organism concentrations and their respective nitrogen fractions, i.e.:

$$Organisms, N = \sum Zb_x - f_{N,Zbx}$$

(Eq. 20)

Unbiodegradable particulate nitrogen is given by:

$$X_{IN} = F_{UP,N} \times F_{UP} \times TCOD$$

(Eq. 21)

The remaining organic nitrogen is broken into particulate and soluble components. Particulate biodegradable organic nitrogen is given by:

$$X_{ON} = (TKN - NH_3 - N_{US} - X_{IN} - Organisms, N) \times F_{NOX}$$

(Eq. 22)

Soluble biodegradable organic nitrogen is given by:

$$N_{OS} = (TKN - NH_3 - N_{US} - X_{IN} - Organisms, N) \times (1 - F_{NOX})$$

(Eq. 23)



Similarly, an explanation of the fractionation of influent phosphorus is as follows. Soluble orthophosphate is given by:

$$PO_4 = F_{PO_4} \times TP$$

(Eq. 24)

Phosphorus from organisms present in the influent is calculated by the sum of the products of the various organism concentrations and their respective phosphorus fractions, i.e.:

$$Organisms, P = \sum Zb_x - f_{P,zbx}$$

(Eq. 25)

Unbiodegradable particulate phosphorus is given by:

$$X_{IN} = F_{UP,P} \times F_{UP} \times TCOD$$

(Eq. 26)

The remaining particulate biodegradable organic phosphorus is given by:

$$X_{OP} = TP - PO_4 - X_{IP} - Organisms, P$$

(Eq. 27)



Appendix 4. Winter 2022 results dynamic model validation

Winter operation process flow diagram

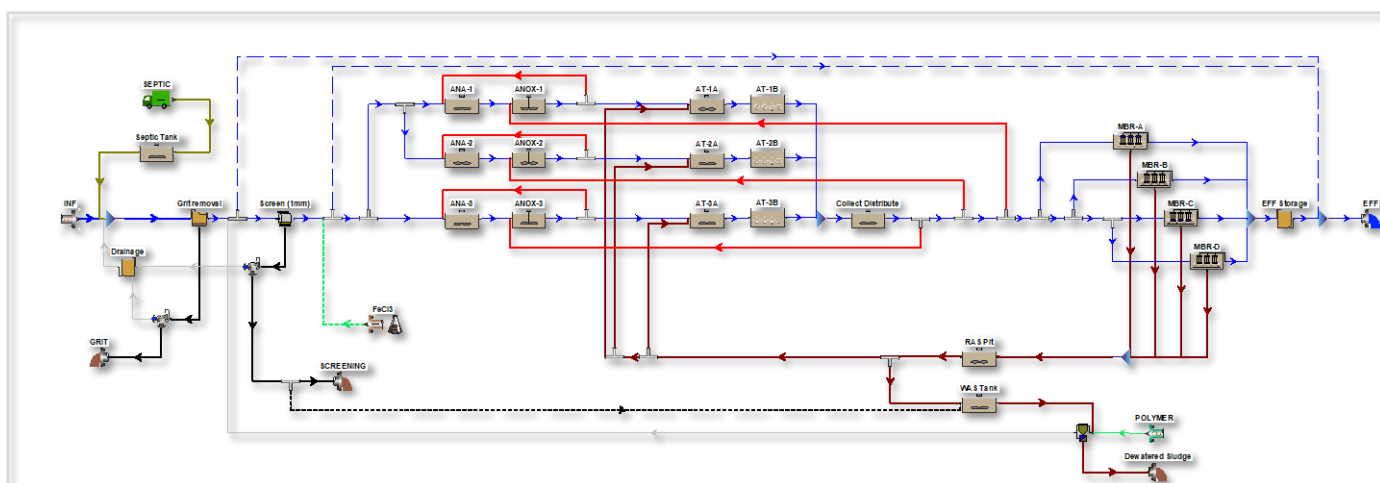

Figure 35. WWTP Poreč-North - BioWin model winter operation. All lines and MBR's are in operation (dashed lines not operated).

Average performance overview

Based on the total dataset the average WWTP performance is calculated and presented in the tables below. The effluent performance and aerobic SRT is well within the design criteria. There are no solids measured in the effluent because of the MBR technology. Total nitrogen is well below the effluent standard. Effluent COD is largely inert soluble material.

Table 6. WWTP Poreč-North - Winter 2019 - Dynamic average effluent concentration (mg/L)

| WWTP Poreč-North - Scenario Winter 2022 - Dynamic average effluent concentration (mg/L) | | | |
|---|------------------------|---------------|------|
| EFF | Temperature | Concentration | 10,0 |
| EFF | COD - Total | Concentration | 42,1 |
| EFF | N - Total N | Concentration | 5,7 |
| EFF | P - Total P | Concentration | 0,3 |
| EFF | Total suspended solids | Concentration | 0,0 |

Table 7. WWTP Poreč-North - Winter 2019 - Dynamic average Air flow rate (m3/h)

| WWTP Poreč-North - Scenario Winter 2022 - Dynamic average Air flow rate (m3/h) | | | |
|--|---------------|------|-------|
| AT-1A | Air flow rate | Flow | 11,0 |
| AT-1B | Air flow rate | Flow | 440,5 |
| AT-2A | Air flow rate | Flow | 11,0 |
| AT-2B | Air flow rate | Flow | 440,5 |
| AT-3A | Air flow rate | Flow | 11,0 |
| AT-3B | Air flow rate | Flow | 438,3 |
| MBR-A | Air flow rate | Flow | 650,0 |
| MBR-B | Air flow rate | Flow | 650,0 |
| MBR-C | Air flow rate | Flow | 650,0 |
| MBR-D | Air flow rate | Flow | 650,0 |

Table 8. WWTP Poreč-North - Winter 2019 - Dynamic average Flows (m3/d)

| WWTP Poreč-North - Scenario Winter 2022 - Dynamic average Flows (m3/d) | | | |
|--|--|----------|--------------|
| ANA-R1 | | Flow (S) | Flow 2.296,0 |
| ANA-R2 | | Flow (S) | Flow 2.296,0 |
| ANA-R3 | | Flow (S) | Flow 2.296,0 |
| ANOX-R1 | | Flow (S) | Flow 4.866,7 |
| ANOX-R2 | | Flow (S) | Flow 4.866,7 |
| ANOX-R3 | | Flow (S) | Flow 4.866,7 |
| AS Emergency Bypass | | Flow (S) | Flow 0,0 |
| Dewatering Centrifuge | | Flow (U) | Flow 2,7 |
| Grit removal | | Flow (U) | Flow 0,4 |
| MBR-A | | Flow (U) | Flow 9.125,0 |
| MBR-B | | Flow (U) | Flow 9.125,0 |
| MBR-C | | Flow (U) | Flow 9.125,0 |
| MBR-D | | Flow (U) | Flow 9.125,0 |
| Screen (1mm) | | Flow (U) | Flow 0,4 |
| Screen Emergency Bypass | | Flow (S) | Flow 0,0 |
| WAS Splitter | | Flow (S) | Flow 92,3 |

Table 9. WWTP Poreč-North - Winter 2019 - Dynamic average sludge production SRT and HRT.

| WWTP Poreč-North - Scenario Winter 2022 - Dynamic average SRT and HRT | |
|---|---------------|
| Temperature | 10 °C |
| Average waste sludge production | 533,7 kgTSS/d |
| SRT Total | 24,8 d |
| SRT Aerobic | 8,1 d |
| SRT AT+ANOX | 16,1 d |
| WAS Tank HRT | 1,8 hour |
| ANA HRT to influent | 7,9 hour |



Table 10. WWTP Poreč-North - Winter 2019 - Dynamic average Iron and Polymer (mg/L, kg/d, m3/d).

| WWTP Poreč-North - Scenario Winter 2022 - Dynamic average Iron and Polymer (mg/L & kg/d) | | | |
|--|------------------------|---------------|---------|
| FeCl3 | Flow | Flow | 0,000 |
| FeCl3 | Total iron (all forms) | Concentration | 150.000 |
| FeCl3 | Total iron (all forms) | Load | 0,000 |
| POLYMER | COD - Total | Concentration | 18.180 |
| POLYMER | COD - Total | Load | 6,192 |
| POLYMER | Flow | Flow | 0,341 |

Influent modelling results

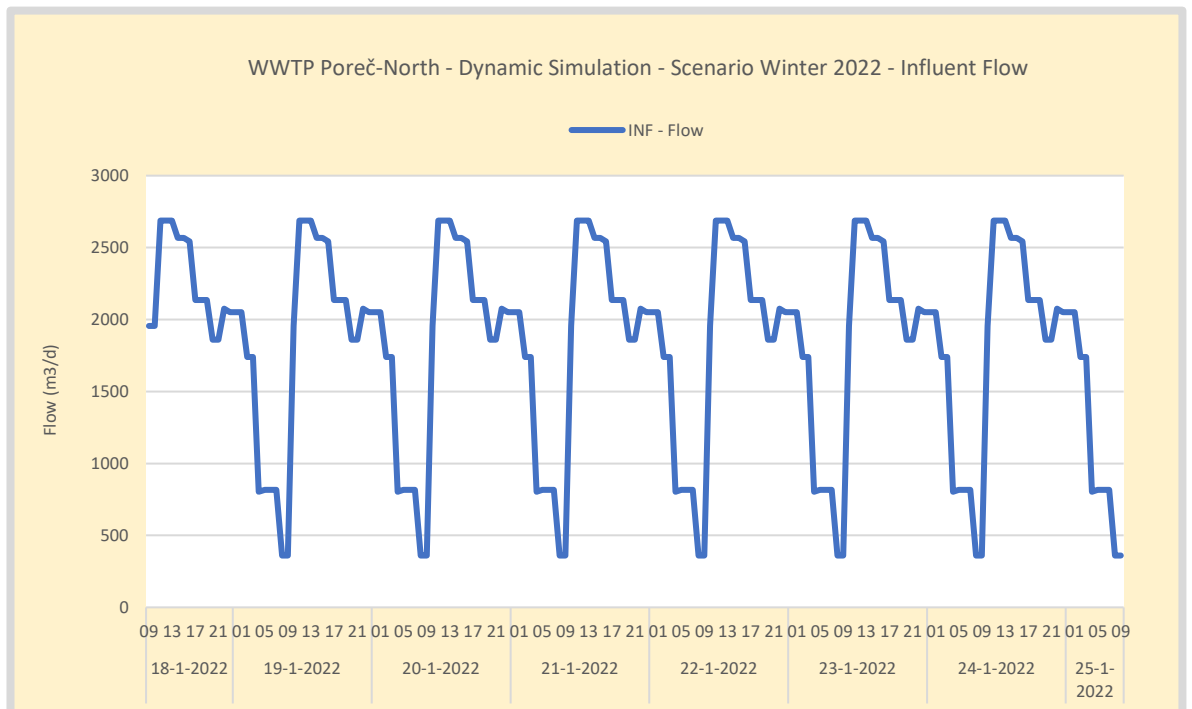

Figure 36. Winter 2022 - WWTP Poreč-North dynamic model Influent flow.



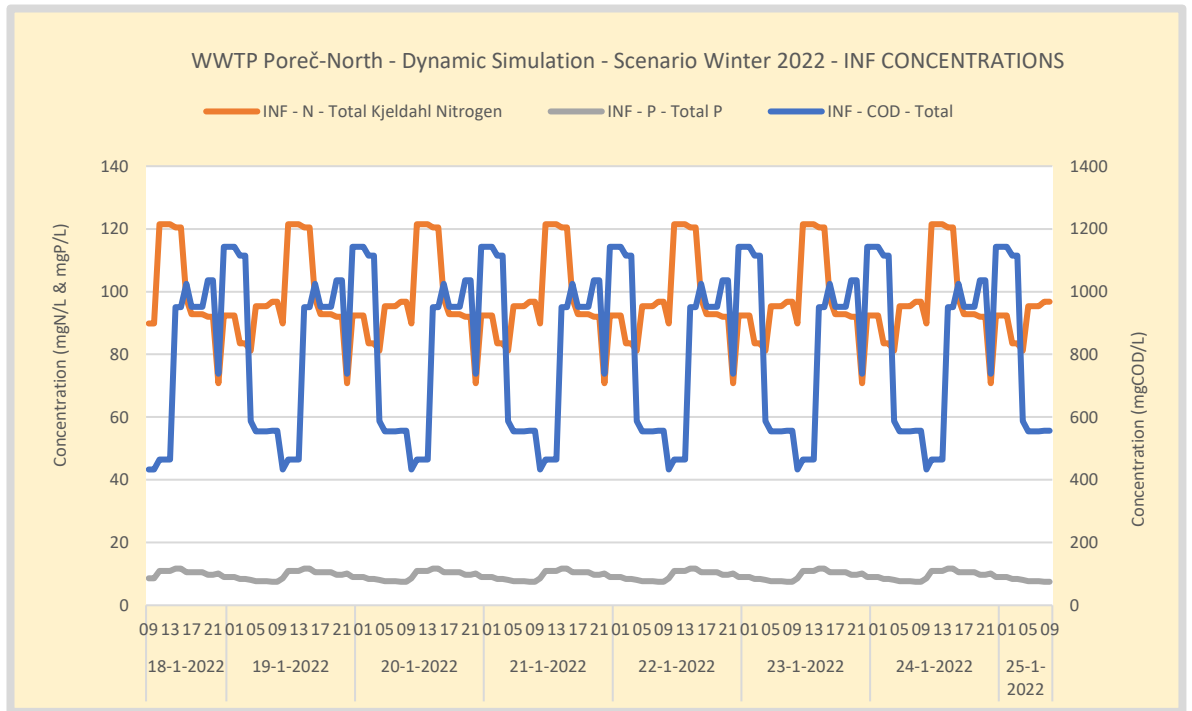

Figure 37. Winter 2022 - WWTP Poreč-North dynamic Influent load COD, TKN and TP.

Process and recycle flows modelling results

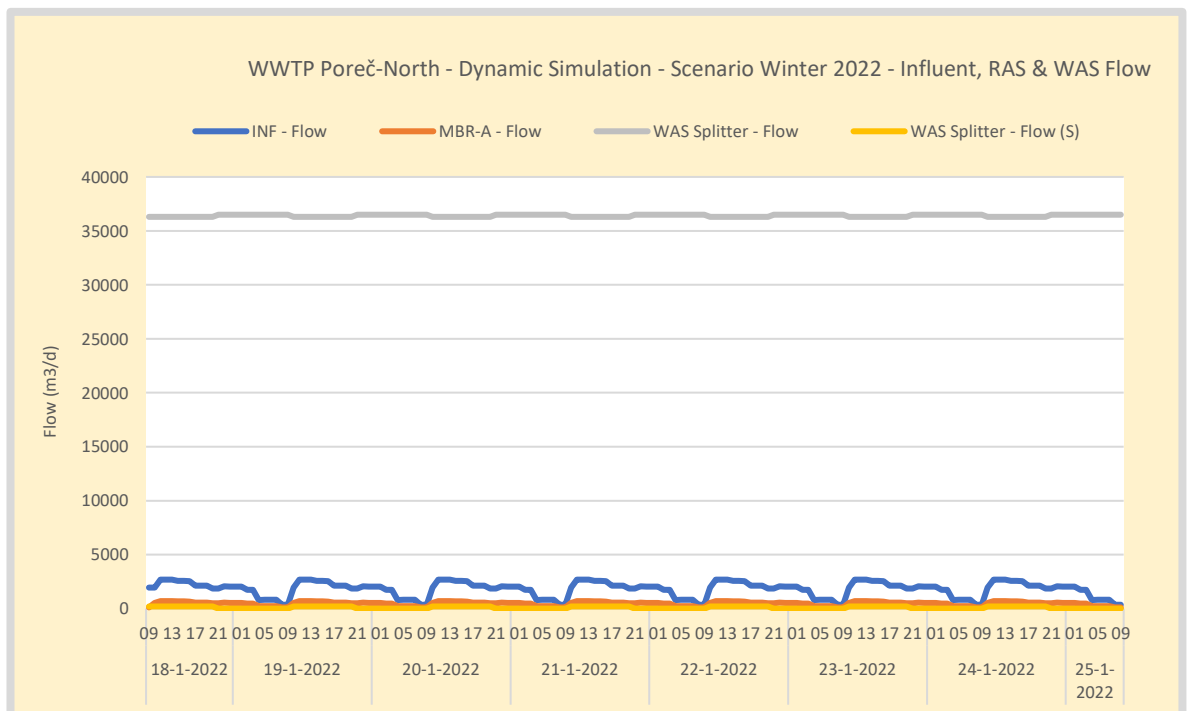

Figure 38. Winter 2022 - WWTP Poreč-North flow rate settings and control. The MLSS sludge return flow is according to the maximum design value. This results in a more stable TSS concentration and denitrification in the winter. The WAS flow is operated 10 hours a day on a constant flow to the dewatering.



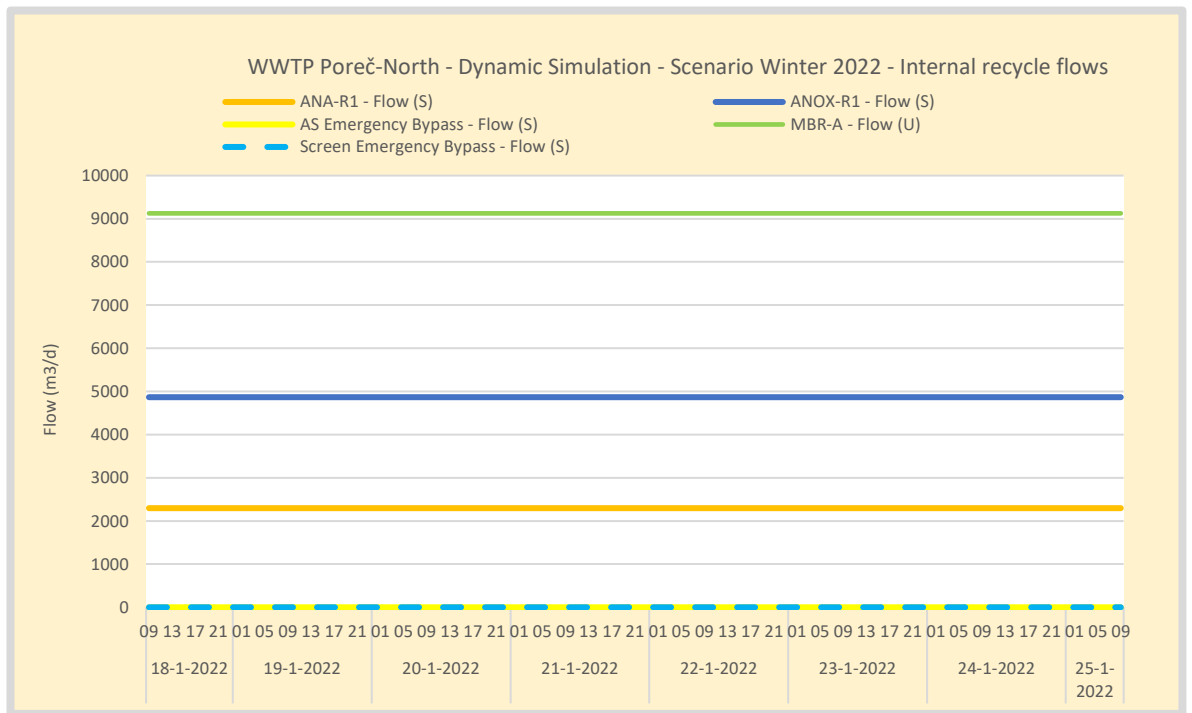

Figure 39. Winter 2022 - WWTP Poreč-North flow rate settings and control. The bypasses are not used. The upper bound of the anoxic, anaerobic and MBR recycle are according to the design.

Waterline operation modelling results

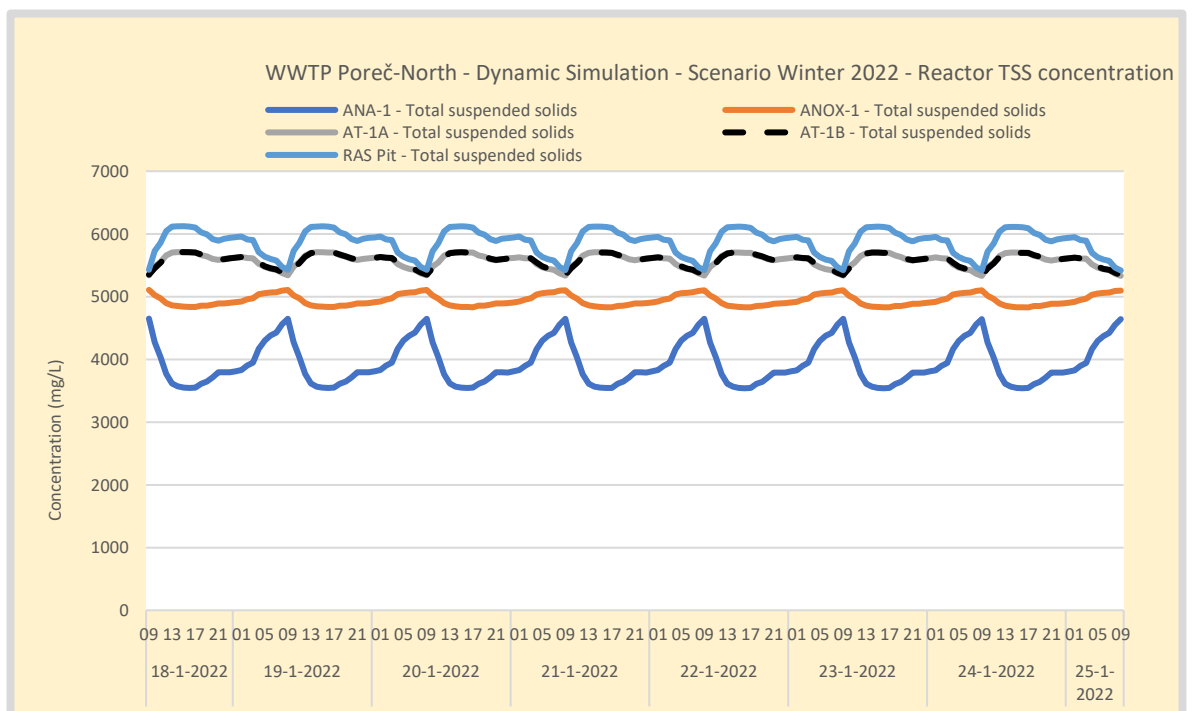

Figure 40. Winter 2022 - WWTP Poreč-North TSS profile in the waterline. TSS in the MBR is controlled on approximately 5,5 gTSS/L by adjusting the WAS flow and SRT. In the winter, the reactor volume relative to the influent loading is very high. This results in low sludge production and a too long SRT. The process is therefore operated with a lower TSS concentration during the winter.



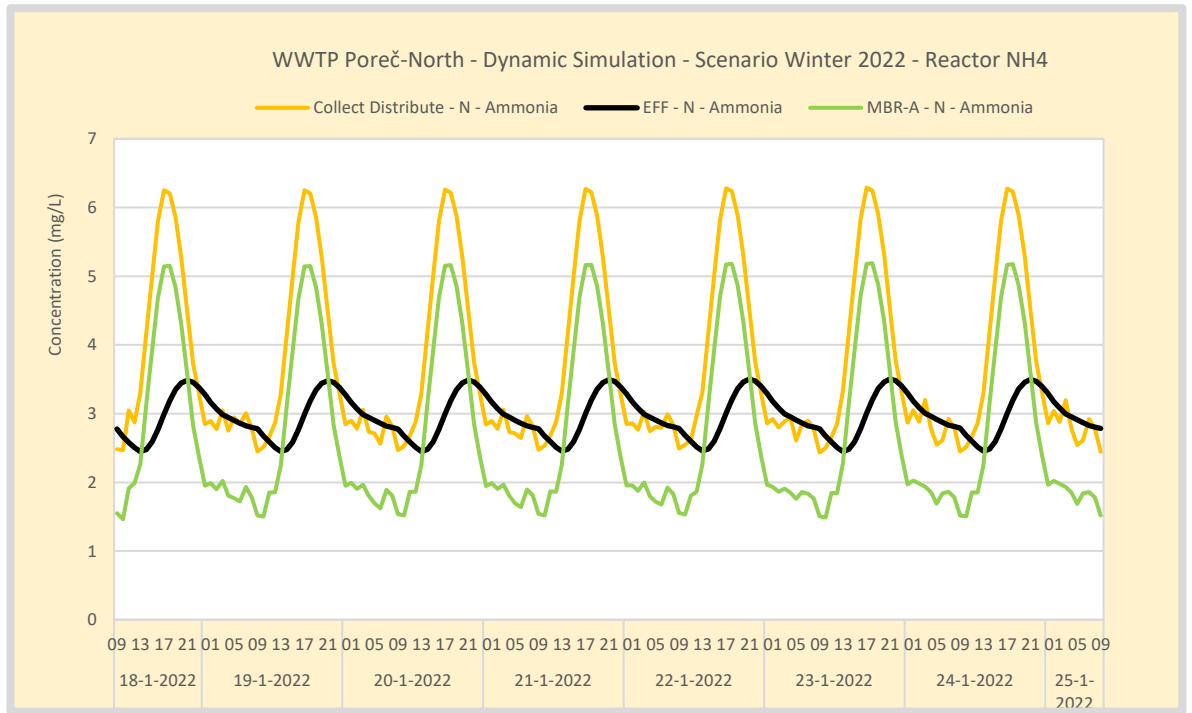

Figure 41. Winter 2022 - WWTP Poreč-North ammonium profile in the waterline. The air input of AT-B is controlled based on NH4 measurements. AT-B comes in operation when AT-A reaches the max air flow rate of 740 m3/h.

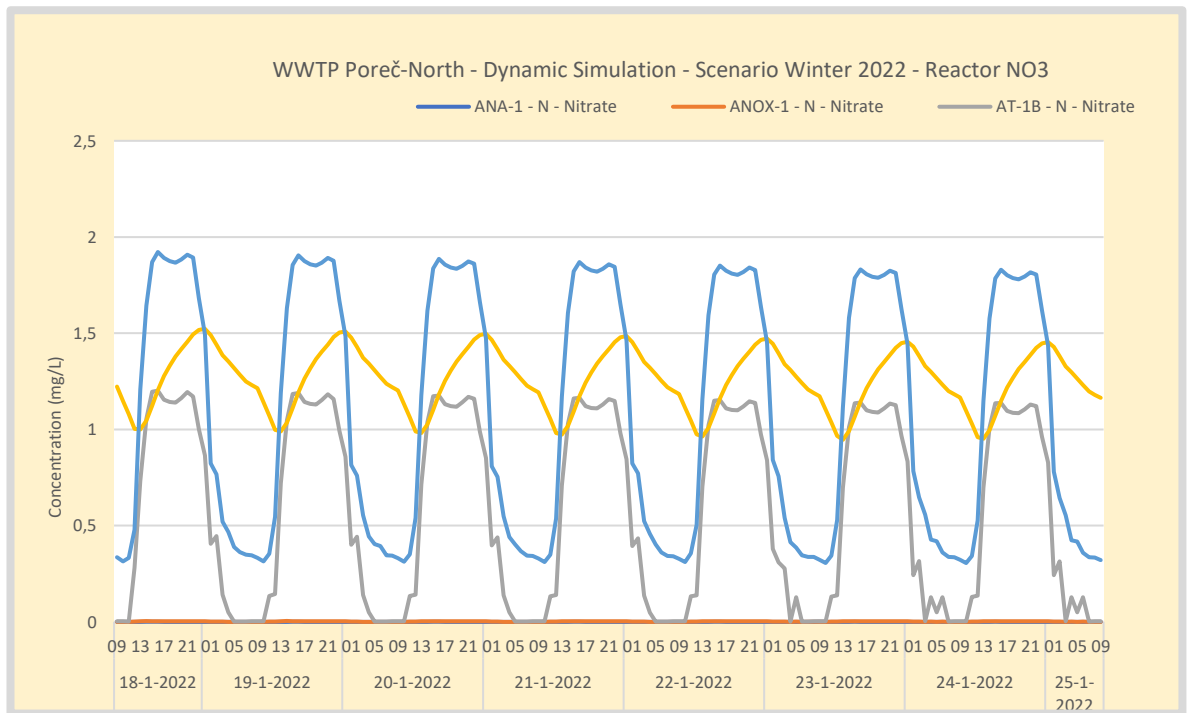

Figure 42. Winter 2022 - WWTP Poreč-North nitrate in the anoxic tank.

Waterline concentration profiles modelling results



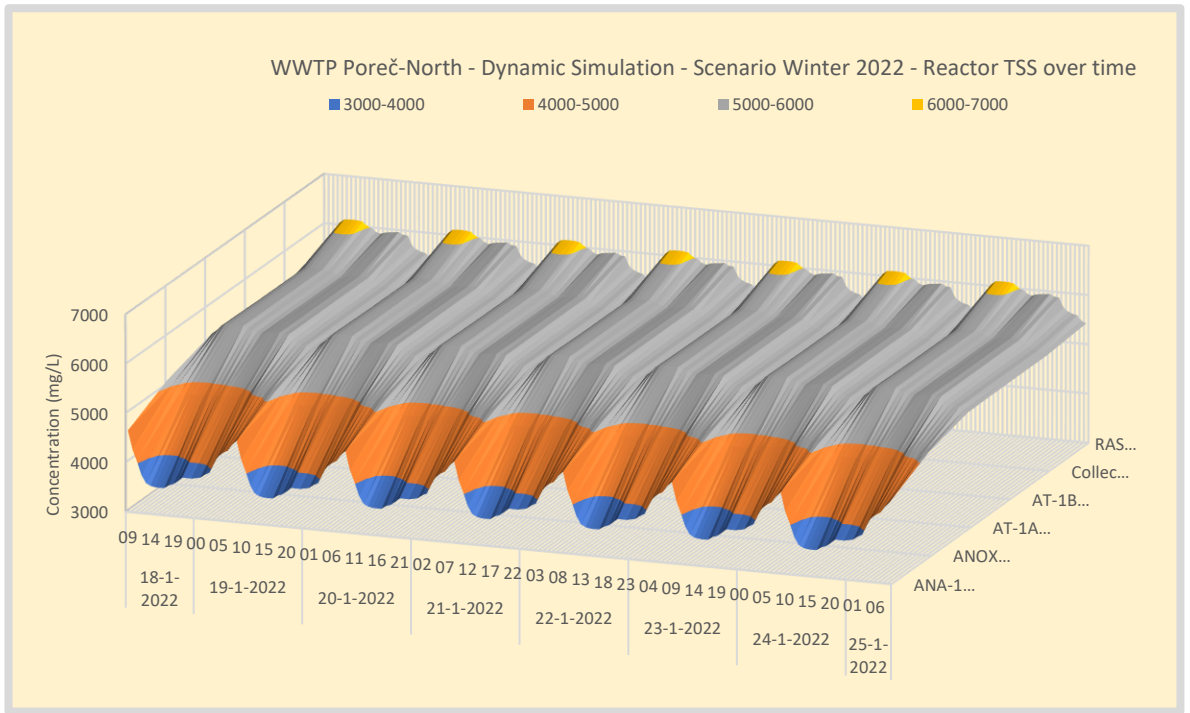

Figure 43. Winter 2022 - WWTP Poreč-North TSS concentration profile over the waterline.

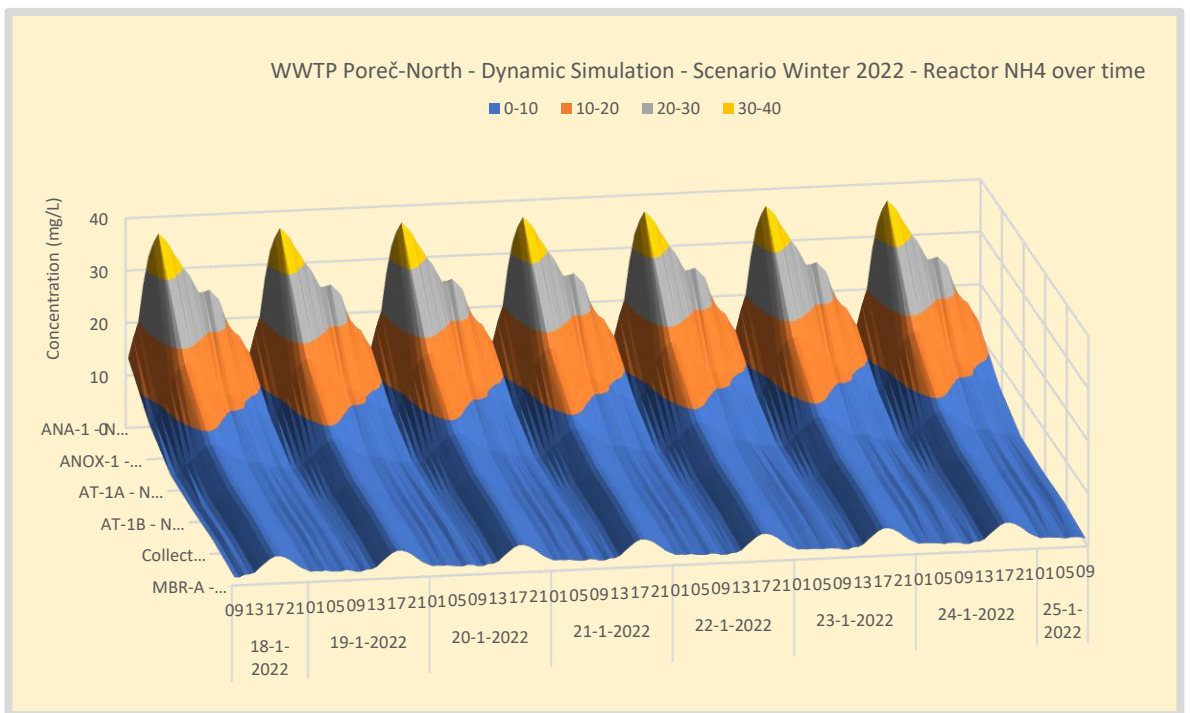

Figure 44. Winter 2022 - WWTP Poreč-North NH4 concentration profile over the waterline.



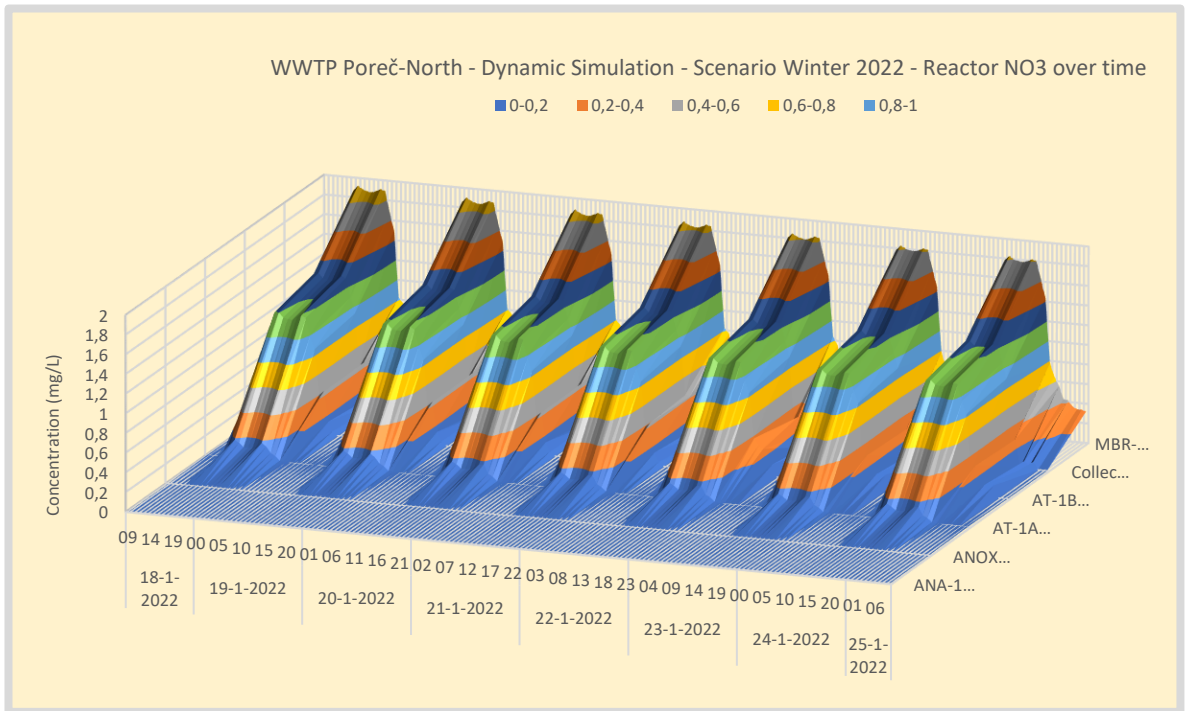

Figure 45. Winter 2022 - WWTP Poreč-North NO3 concentration profile over the waterline.

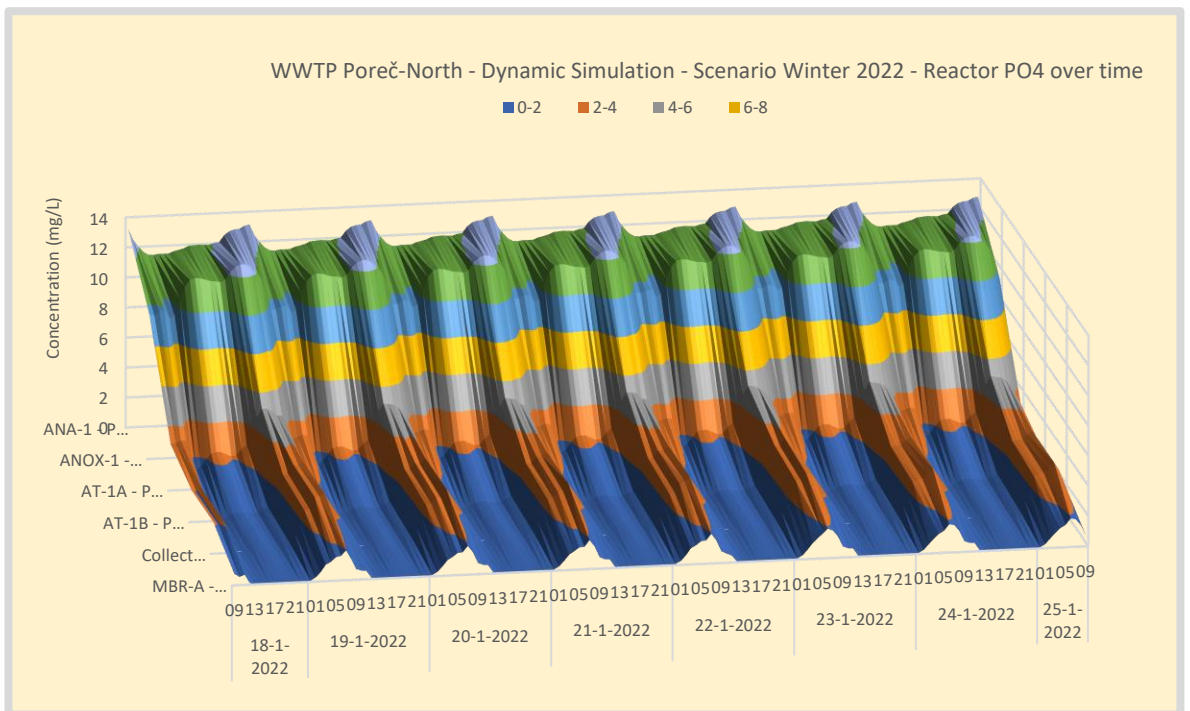

Figure 46. Winter 2022 - WWTP Poreč-North PO4 concentration profile over the waterline.



Aeration and DO concentration modelling results

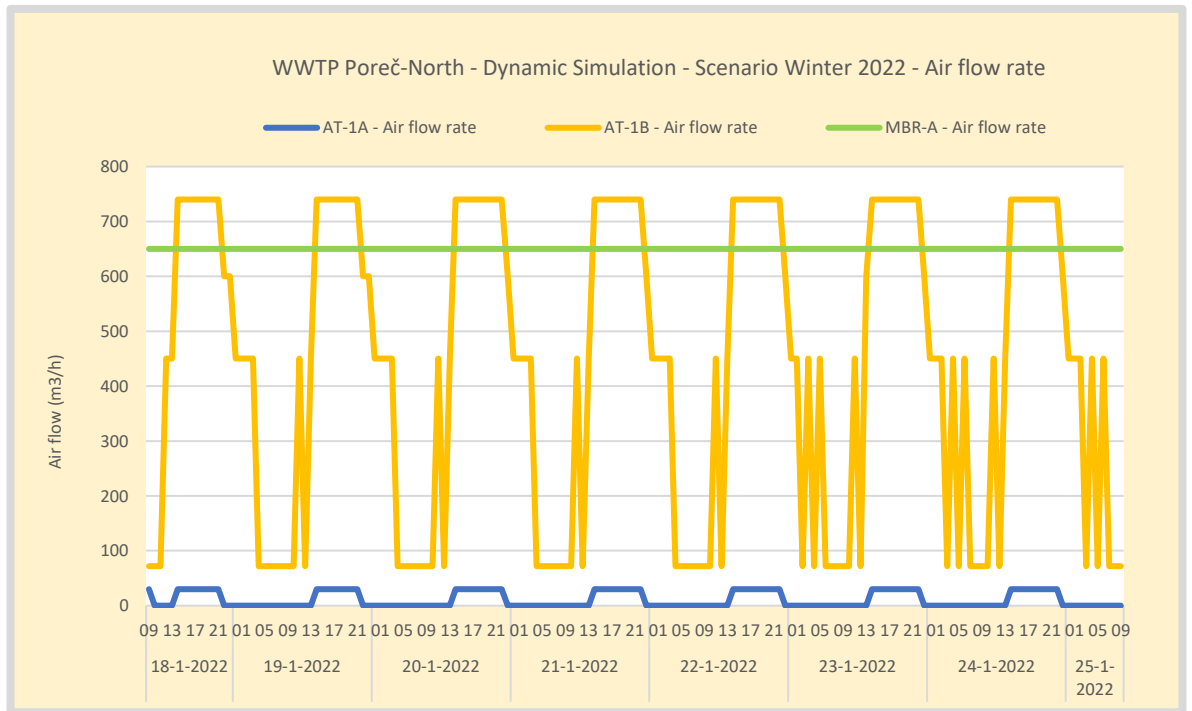

Figure 47. Winter 2022 - WWTP Poreč-North air input in the different aerated reactors. AT-A comes in operation when AT-B is at its maximum air flow rate of 740 m³/h. AT-B is set controlled based on the NH₄ concentration. MBR-A is controlled on the maximum installed air flow capacity.

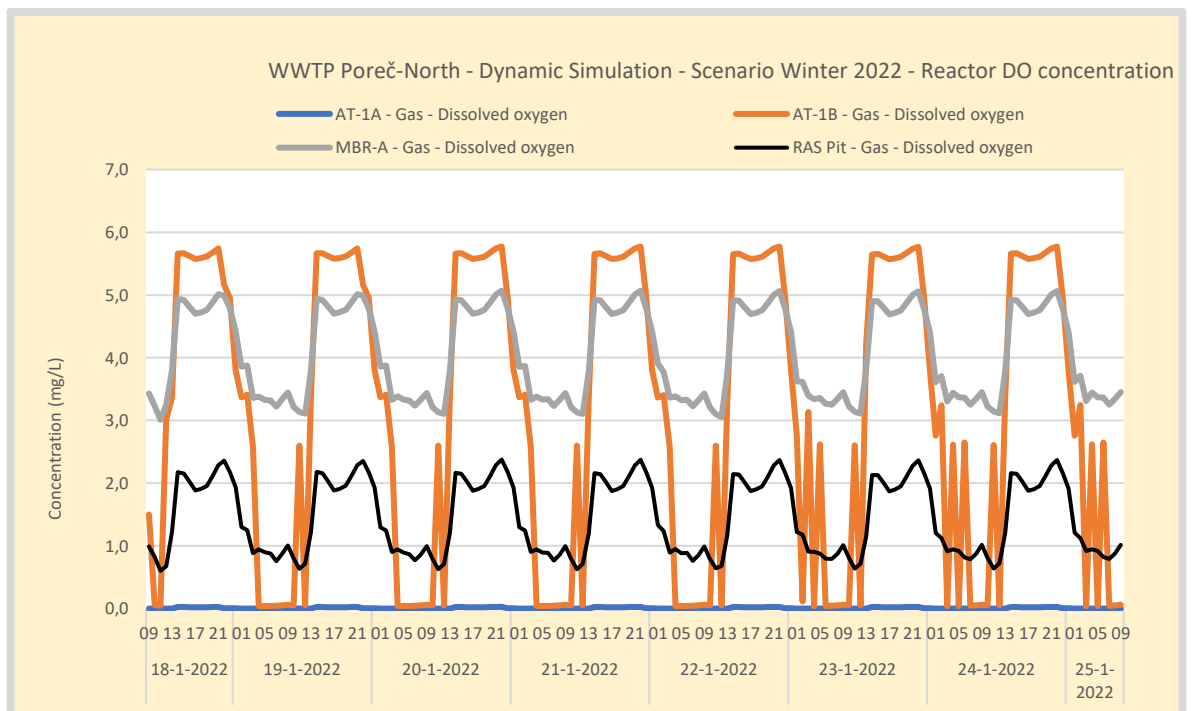

Figure 48. Winter 2022 - WWTP Poreč-North DO concentration gradients. DO is controlled in the AT and MBR. DO is the result of the designed air input.



pH and alkalinity profiles modelling results

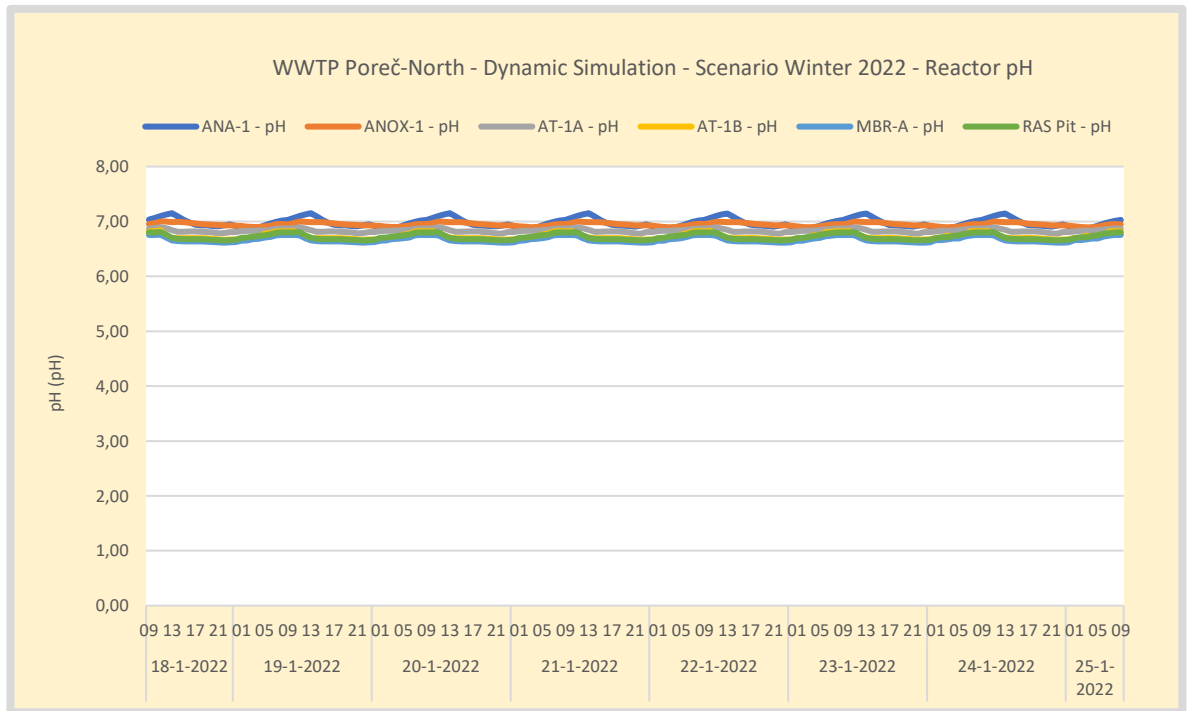

Figure 49. Winter 2022 - WWTP Poreč-North pH profile over the activated sludge reactors. Influent pH is measured continuously and is not limiting.

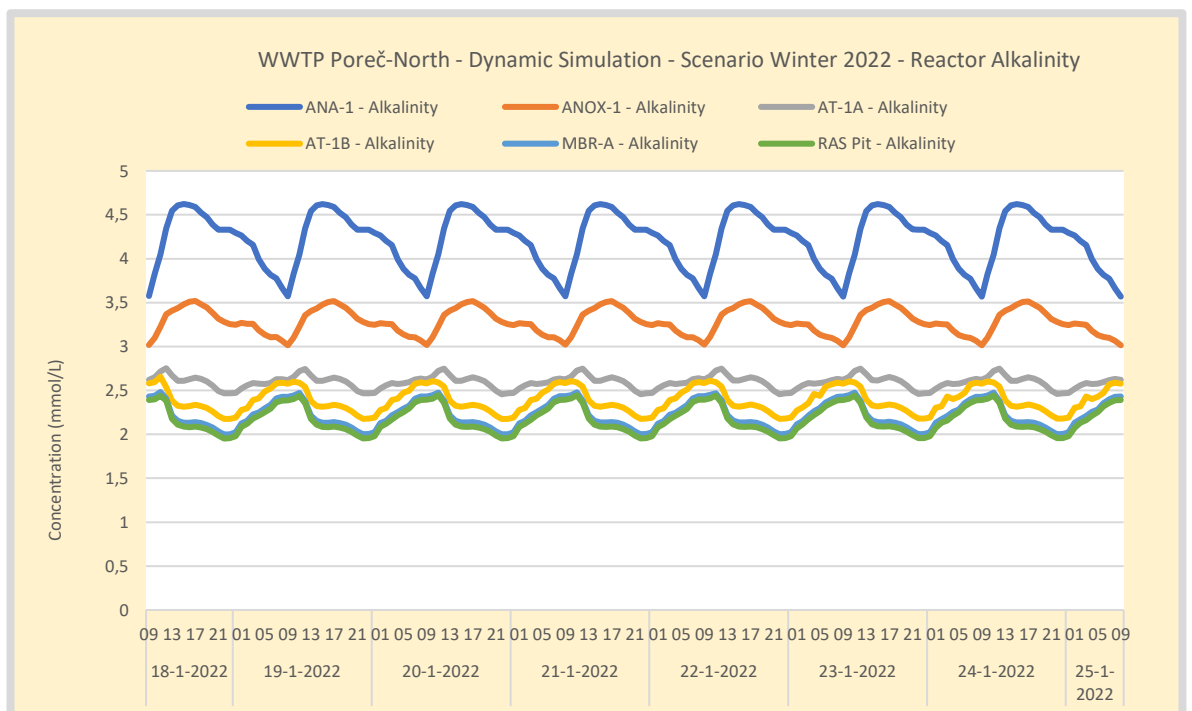

Figure 50. Winter 2022 - WWTP Poreč-North alkalinity profile over the activated sludge reactors. Influent alkalinity is estimated from local drinking water quality measurements at 7,46 mmol/L. Alkalinity is not limiting.



Chemical load and flow modelling results

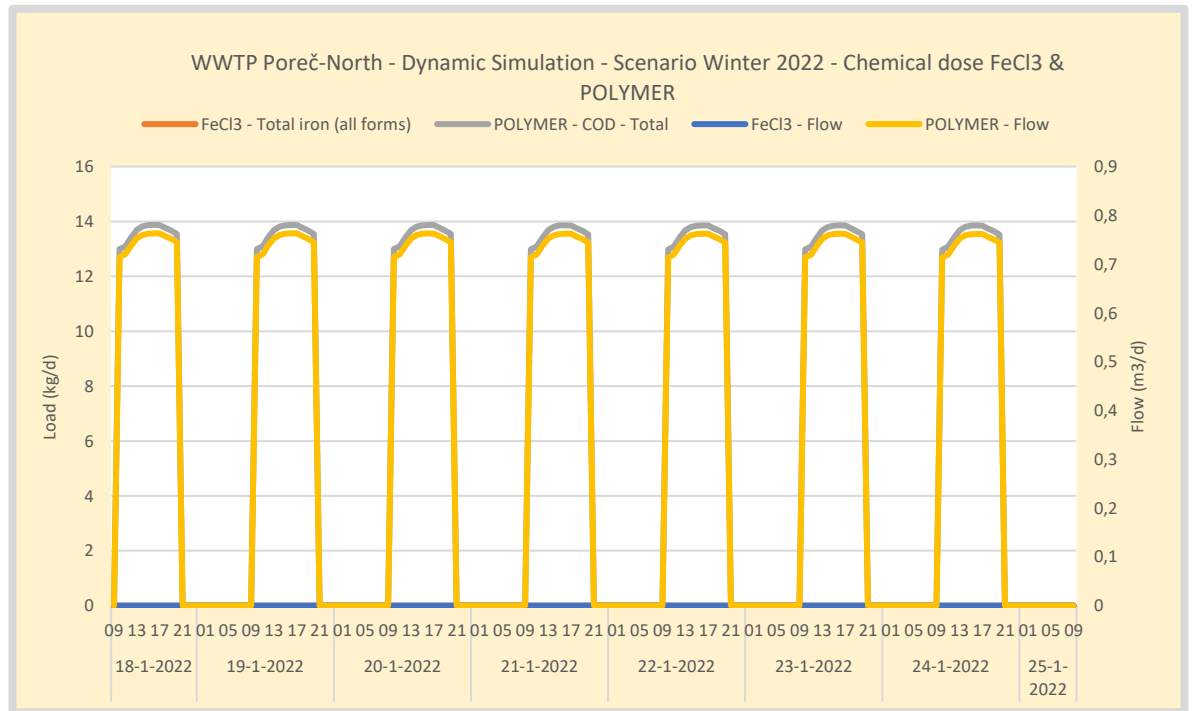

Figure 51. Winter 2022 - WWTP Poreč-North load and flow of Iron and PE. No Iron dosage is required for P-removal. PE is assumed particulate biodegradable COD with a COD/VSS ratio of 1,42 gCOD/gTSS and dosed proportional to the WAS load based on 8 kg PE (dry weight) dosed per 1000 kg WAS (dry weight) flowing in the dewatering.

Sludge line operation modelling results

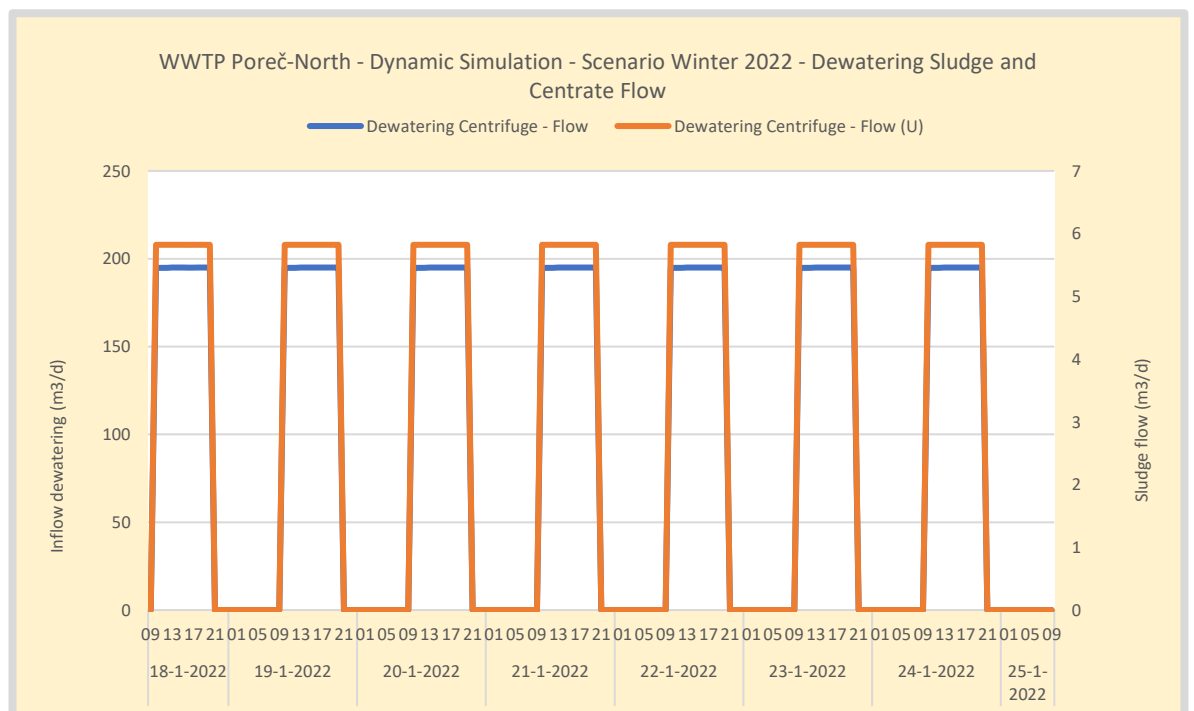

Figure 52. Winter 2022 - WWTP Poreč-North dewatered sludge and centrate flow.



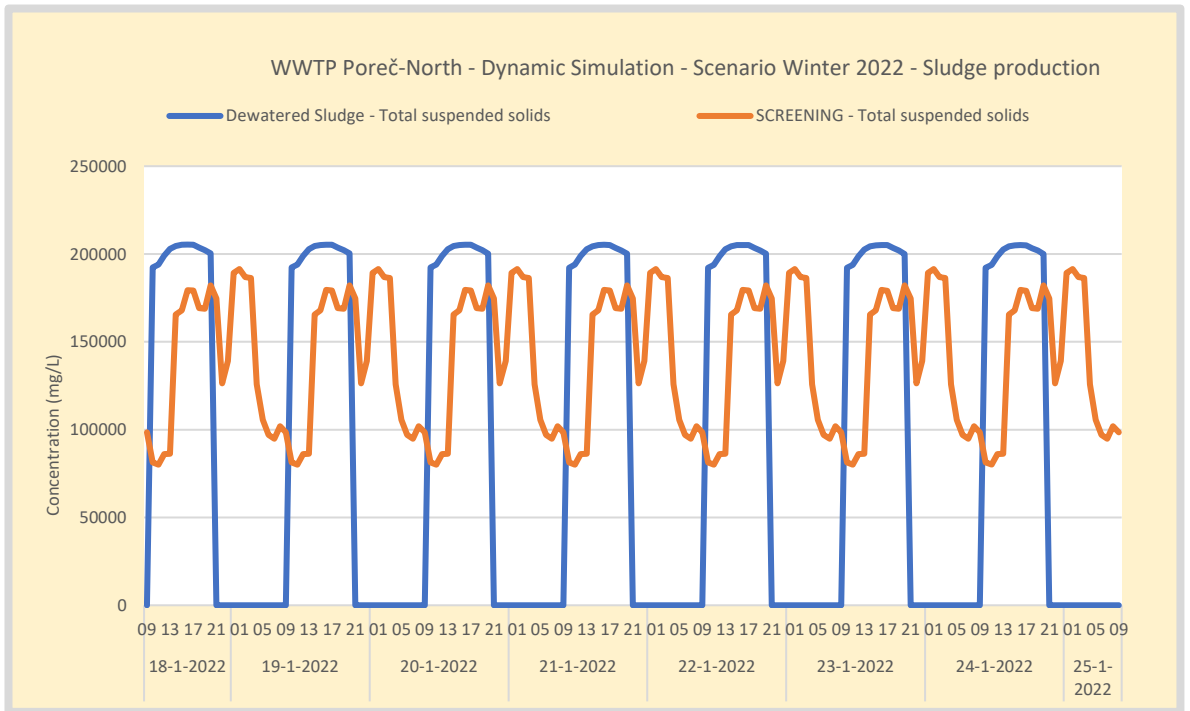

Figure 53. Winter 2022 - WWTP Poreč-North dewatered sludge and screening sludge concentration. The design assumes dewatered sludge at 23% dry matter. Screening is an estimated concentration as the result of the press operation.

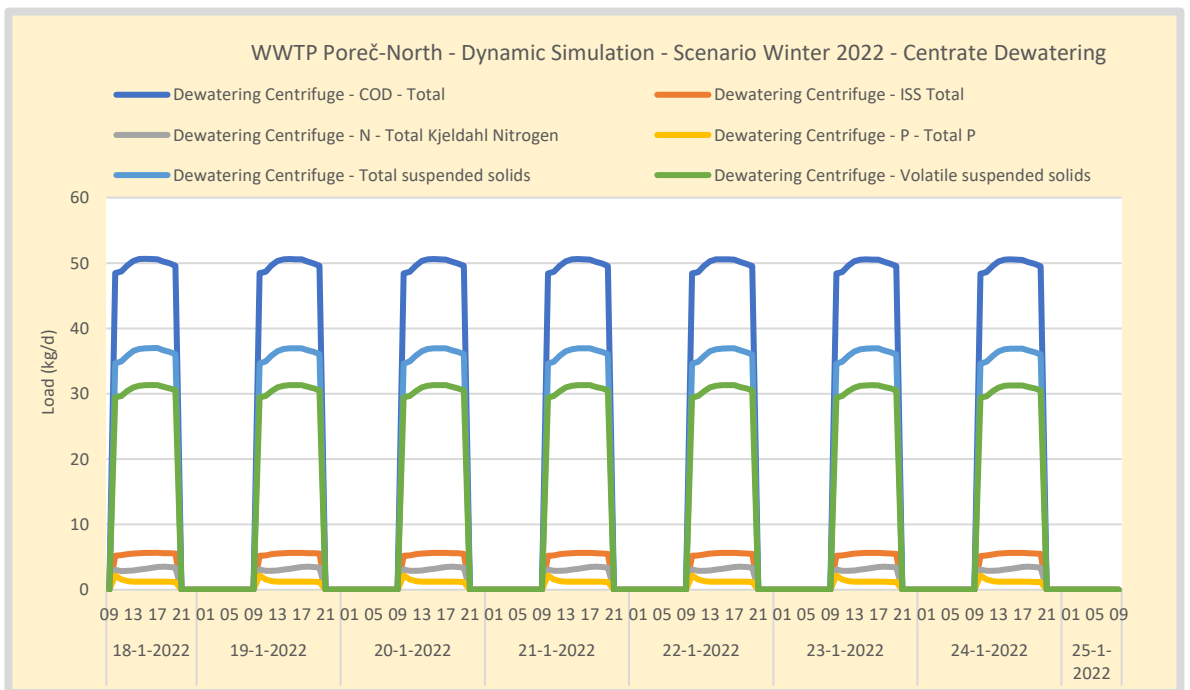

Figure 54. Winter 2022 - WWTP Poreč-North Centrate load dewatering.



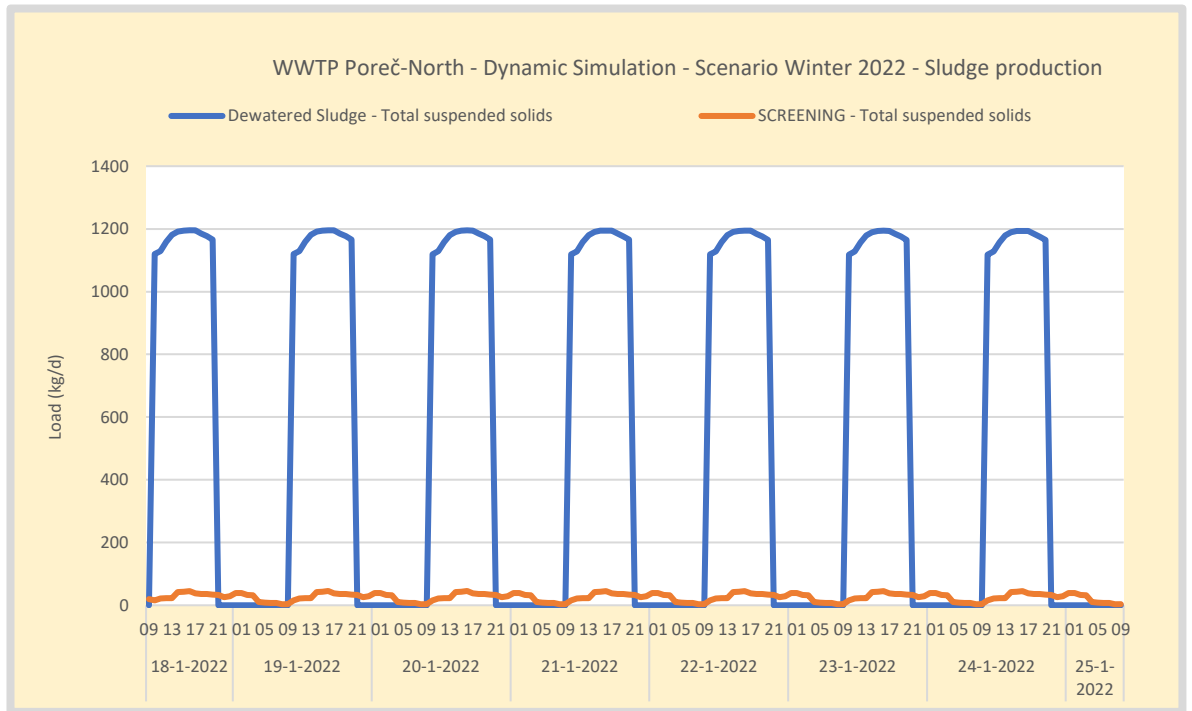

Figure 55. Winter 2022 - WWTP Poreč-North dewatered sludge load and compacted screening load. Dewatered sludge is operated 10 hours a day at 23%. Screening is produces continuously as a factor of the influent.

Effluent modelling results

In the figures below the dynamic effluent quality of the plant is presented under winter conditions. The last day included a major rain event. The measurement is coming from the effluent buffer and has a reduced dynamic profile.

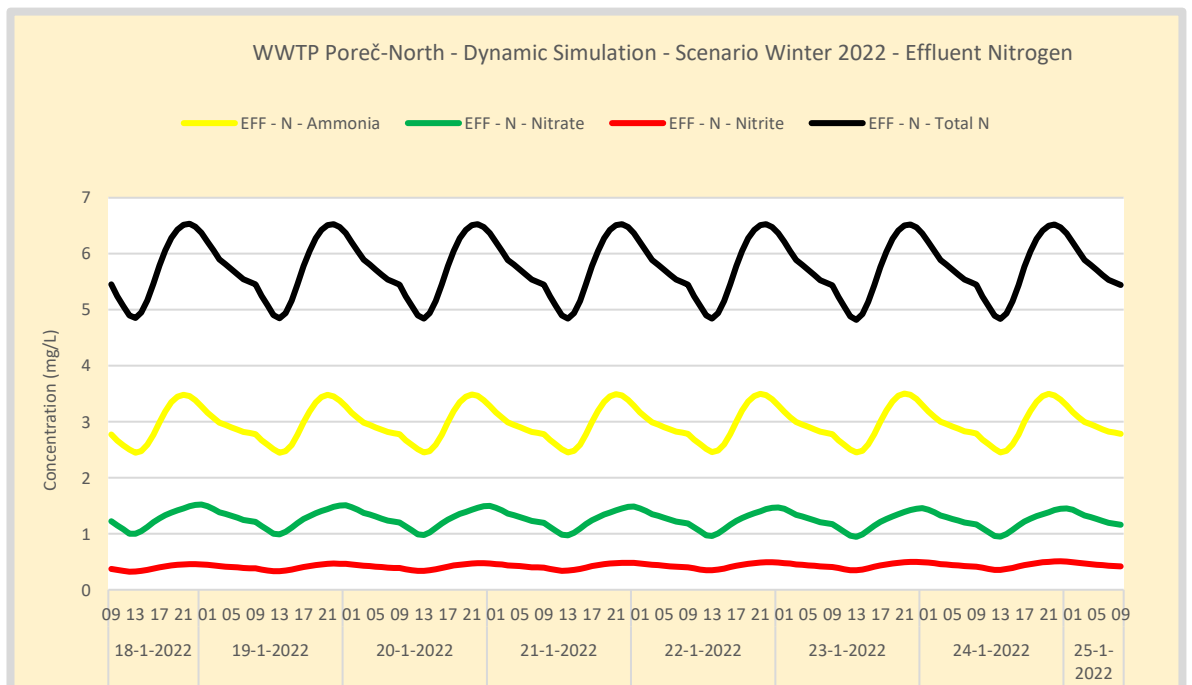

Figure 56. Winter 2022 - WWTP Poreč-North Effluent nitrogen concentration. Effluent is measured in the outflow of the large effluent buffer.



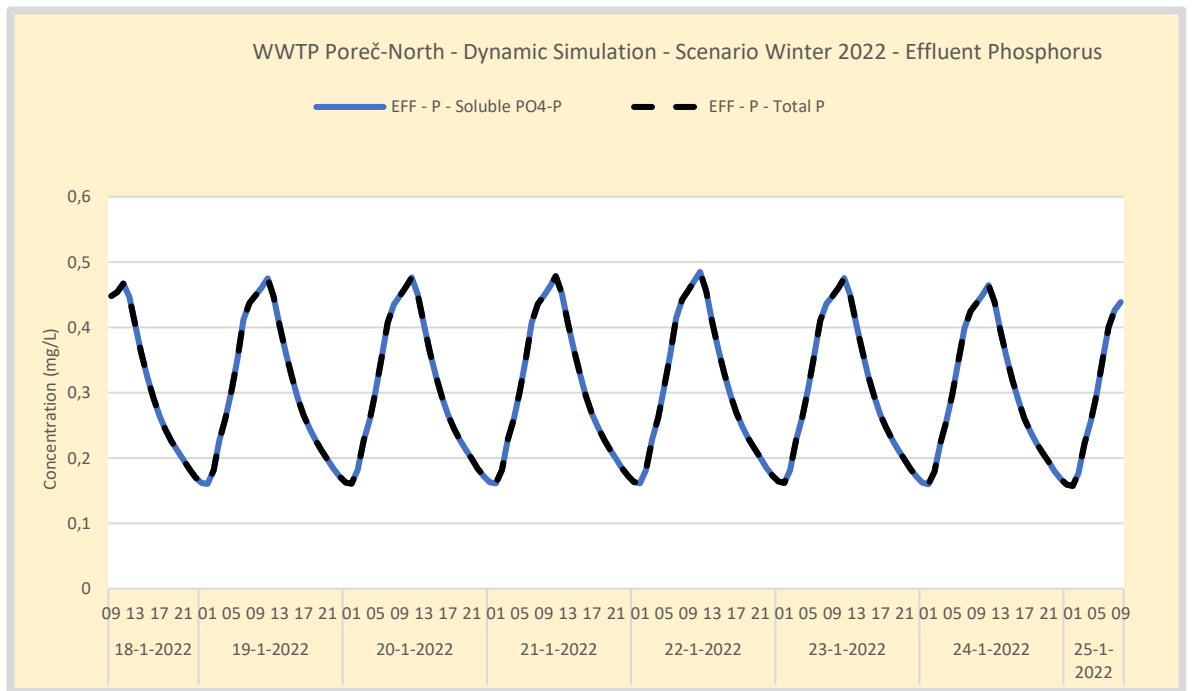

Figure 57. Winter 2022 - WWTP Poreč-North Effluent phosphorus concentration. Effluent is measured in the outflow of the large effluent buffer.

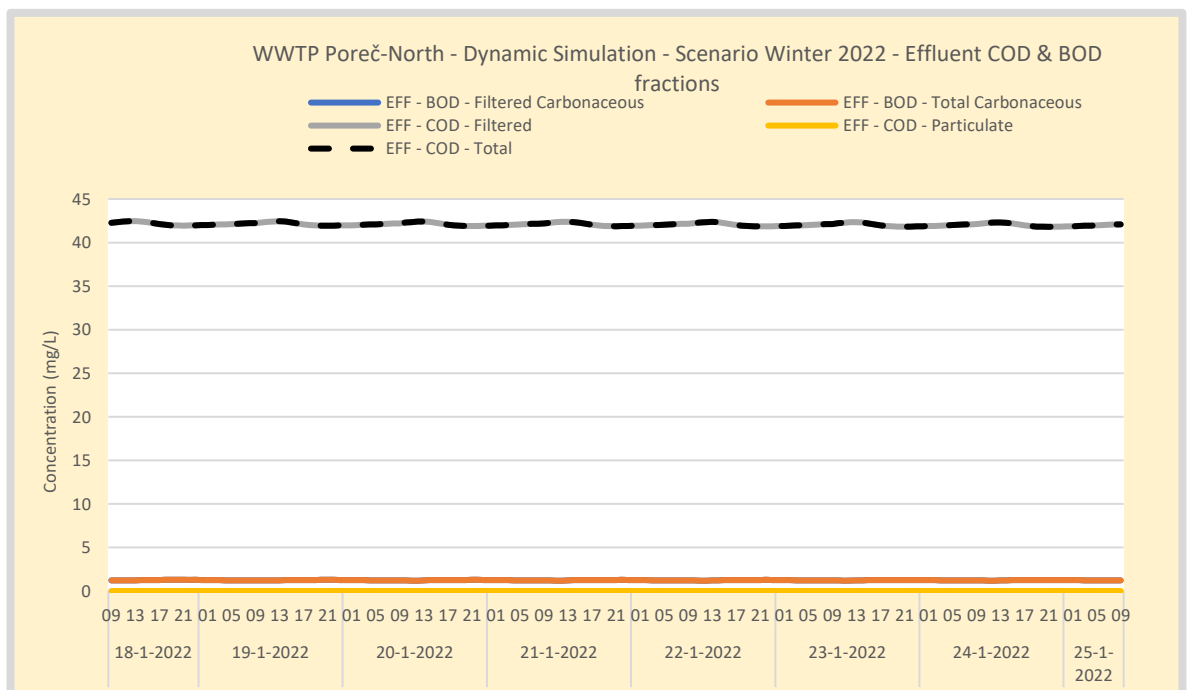

Figure 58. Winter 2022 - WWTP Poreč-North Effluent COD and BOD concentration. Effluent is measured in the outflow of the large effluent buffer.



Appendix 5: BioWin configuration data calibration 2022

BioWin user and configuration data

Project details

Project name: Influent Data Winter 2022 dynamic Project ref.: Winter Dynamic Influent

Plant name: WWTP Porec-North (PONO)
Design B.V.

User name: ASM

Created: 15-2-2022

Saved: 3-3-2022

Dynamic simulation on

SRT Classic: 9,27* days

Temperature: 10,0°C

Flowsheet

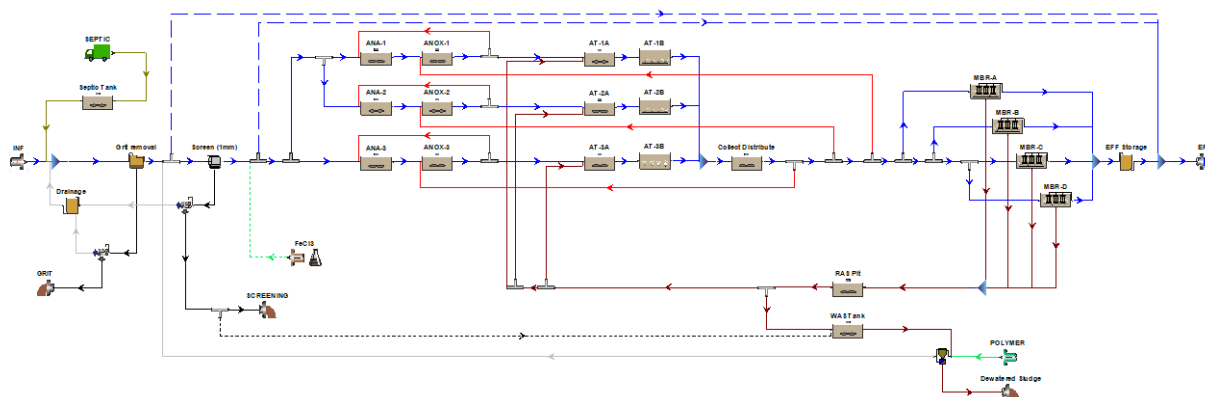

Configuration information for all Bioreactor units

Physical data

| Element name | Volume [m3] | Area [m2] | Depth [m] | # of diffusers |
|--------------------|-------------|-----------|-----------|----------------|
| ANA-1 | 200,0000 | 38,0952 | 5,250 | Un-aerated |
| ANOX-1 | 175,0000 | 33,3333 | 5,250 | Un-aerated |
| AT-1A | 180,0000 | 34,2857 | 5,250 | Un-aerated |
| ANA-3 | 200,0000 | 38,0952 | 5,250 | Un-aerated |
| ANOX-3 | 175,0000 | 33,3333 | 5,250 | Un-aerated |
| AT-3A | 180,0000 | 34,2857 | 5,250 | Un-aerated |
| Collect Distribute | 70,8750 | 13,5000 | 5,250 | Un-aerated |
| RAS Pit | 91,0000 | 45,5000 | 2,000 | Un-aerated |
| WAS Tank | 7,0000 | 0,1321 | 53,000 | Un-aerated |
| ANA-2 | 200,0000 | 38,0952 | 5,250 | Un-aerated |
| ANOX-2 | 175,0000 | 33,3333 | 5,250 | Un-aerated |
| AT-2A | 180,0000 | 34,2857 | 5,250 | Un-aerated |
| Septic Tank | 60,0000 | 1,5385 | 39,000 | Un-aerated |
| AT-1B | 180,0000 | 34,2857 | 5,250 | 163 |
| AT-2B | 180,0000 | 34,2857 | 5,250 | 163 |
| AT-3B | 180,0000 | 34,2857 | 5,250 | 163 |

Operating data Average (flow/time weighted as required)

| Element name | Average DO Setpoint [mg/L] |
|--------------------|----------------------------|
| ANA-1 | 0 |
| ANOX-1 | 0 |
| ANA-3 | 0 |
| ANOX-3 | 0 |
| Collect Distribute | 0 |



| | |
|-------------|---|
| RAS Pit | 0 |
| WAS Tank | 0 |
| ANA-2 | 0 |
| ANOX-2 | 0 |
| Septic Tank | 0 |

| Element name | Average Air flow rate [m3/hr (20C, 1 atm)] |
|--------------|--|
| AT-1A | 0 |
| AT-3A | 0 |
| AT-2A | 0 |
| AT-1B | 3600,0 |
| AT-2B | 3600,0 |
| AT-3B | 3600,0 |

Aeration equipment parameters

| Element name | k_1 in C = $k_1(PC)^{0.25 + k_2}$ | k_2 in C = $k_2(PC)^{0.25 + k_2}$ | Y in $Kla = C U_{sg} \cdot Y$ [m3/(m2 d)] | Area of diffuser | Diffuser mounting height | Min. air flow rate per diffuser (20C, 1 atm) | Max. air flow rate per diffuser (20C, 1 atm) | 'A' in diffuser pressure drop = A + $B^*(Qa/Diff)$ + $C^*(Qa/Diff)^2$ | 'B' in diffuser pressure drop = A + $B^*(Qa/Diff)$ + $C^*(Qa/Diff)^2$ | 'C' in diffuser pressure drop = A + $B^*(Qa/Diff)$ + $C^*(Qa/Diff)^2$ |
|--------------|-------------------------------------|-------------------------------------|--|------------------|--------------------------|--|--|---|---|---|
| ANA-1 | 1,2400 | 0,8960 | 0,8880 | 0,0380 | 0,2500 | 0,5000 | 10,0000 | 3,0000 | 0 | 0 |
| ANOX-1 | 1,2400 | 0,8960 | 0,8880 | 0,0380 | 0,2500 | 0,5000 | 10,0000 | 3,0000 | 0 | 0 |
| AT-1A | 1,2400 | 0,8960 | 0,8880 | 0,0380 | 0,2500 | 0,5000 | 10,0000 | 3,0000 | 0 | 0 |
| ANA-3 | 1,2400 | 0,8960 | 0,8880 | 0,0380 | 0,2500 | 0,5000 | 10,0000 | 3,0000 | 0 | 0 |
| ANOX-3 | 1,2400 | 0,8960 | 0,8880 | 0,0380 | 0,2500 | 0,5000 | 10,0000 | 3,0000 | 0 | 0 |
| AT-3A | 1,2400 | 0,8960 | 0,8880 | 0,0380 | 0,2500 | 0,5000 | 10,0000 | 3,0000 | 0 | 0 |



| | | | | | | | | | | |
|------------|--------|--------|--------|--------|--------|--------|---------|--------|---|---|
| Collect | 1,2400 | 0,8960 | 0,8880 | 0,0380 | 0,2500 | 0,5000 | 10,0000 | 3,0000 | 0 | 0 |
| Distribute | | | | | | | | | | |
| RAS Pit | 1,2400 | 0,8960 | 0,8880 | 0,0380 | 0,2500 | 0,5000 | 10,0000 | 3,0000 | 0 | 0 |
| WAS | 1,2400 | 0,8960 | 0,8880 | 0,0380 | 0,2500 | 0,5000 | 10,0000 | 3,0000 | 0 | 0 |
| Tank | | | | | | | | | | |
| ANA-2 | 1,2400 | 0,8960 | 0,8880 | 0,0380 | 0,2500 | 0,5000 | 10,0000 | 3,0000 | 0 | 0 |
| ANOX-2 | 1,2400 | 0,8960 | 0,8880 | 0,0380 | 0,2500 | 0,5000 | 10,0000 | 3,0000 | 0 | 0 |
| AT-2A | 1,2400 | 0,8960 | 0,8880 | 0,0380 | 0,2500 | 0,5000 | 10,0000 | 3,0000 | 0 | 0 |
| Septic | 1,2400 | 0,8960 | 0,8880 | 0,0380 | 0,2500 | 0,5000 | 10,0000 | 3,0000 | 0 | 0 |
| Tank | | | | | | | | | | |
| AT-1B | 1,2400 | 0,8960 | 0,8880 | 0,0380 | 0,2500 | 0,5000 | 10,0000 | 3,0000 | 0 | 0 |
| AT-2B | 1,2400 | 0,8960 | 0,8880 | 0,0380 | 0,2500 | 0,5000 | 10,0000 | 3,0000 | 0 | 0 |
| AT-3B | 1,2400 | 0,8960 | 0,8880 | 0,0380 | 0,2500 | 0,5000 | 10,0000 | 3,0000 | 0 | 0 |

Configuration information for all Bioreactor - MBR units

Physical data

| Element name | Volume [m3] | Area [m2] | Depth [m] | # of diffusers | # of cassettes | Displaced volume / cassette [m3/cassete] | Membrane area / cassette [m2/cassete] | Total displaced volume [m3] | Membrane surface area [m2] |
|--------------|-------------|-----------|-----------|----------------|----------------|--|---------------------------------------|-----------------------------|----------------------------|
| MBR-A | 60,0000 | 11,4286 | 5,250 | 80 | 2,00 | 1,690 | 2612,00 | 3,38 | 5224,00 |
| MBR-B | 60,0075 | 11,4300 | 5,250 | 80 | 2,00 | 1,690 | 2612,00 | 3,38 | 5224,00 |
| MBR-C | 60,0000 | 11,4286 | 5,250 | 80 | 2,00 | 1,690 | 2612,00 | 3,38 | 5224,00 |
| MBR-D | 60,0000 | 11,4286 | 5,250 | 80 | 2,00 | 1,690 | 2612,00 | 3,38 | 5224,00 |

Operating data Average (flow/time weighted as required)

| Element name | Split method | Average Split specification |
|--------------|--------------|-----------------------------|
|--------------|--------------|-----------------------------|



| | | |
|-------|------------------|------|
| MBR-A | Flowrate [Under] | 9125 |
| MBR-B | Flowrate [Under] | 9125 |
| MBR-C | Flowrate [Under] | 9125 |
| MBR-D | Flowrate [Under] | 9125 |

| Element name | Average Air flow rate [m3/hr (20C, 1 atm)] |
|--------------|--|
| MBR-A | 650,0 |
| MBR-B | 650,0 |
| MBR-C | 650,0 |
| MBR-D | 650,0 |

Aeration equipment parameters

| Element name | k_1 in C = $k_1(PC)^{0.25 + k_2}$ | k_2 in C = $k_1(PC)^{0.25 + k_2}$ | Y in $Kla = C U_{sg} \cdot Y$ [m3/(m2 d)] | Area of diffuser | Diffuser mounting height | Min. air flow rate per diffuser (20C, 1 atm) | Max. air flow rate per diffuser (20C, 1 atm) | 'A' in diffuser pressure drop = A + $B^*(Qa/Diff) + C^*(Qa/Diff)^2$ | 'B' in diffuser pressure drop = A + $B^*(Qa/Diff) + C^*(Qa/Diff)^2$ | 'C' in diffuser pressure drop = A + $B^*(Qa/Diff) + C^*(Qa/Diff)^2$ |
|--------------|-------------------------------------|-------------------------------------|---|------------------|--------------------------|--|--|---|---|---|
| MBR-A | 0,0500 | 0,3800 | 1,0000 | 0,0500 | 0,2500 | 2,0000 | 50,0000 | 1,0000 | 0 | 0 |
| MBR-B | 0,0500 | 0,3800 | 1,0000 | 0,0500 | 0,2500 | 2,0000 | 50,0000 | 1,0000 | 0 | 0 |
| MBR-C | 0,0500 | 0,3800 | 1,0000 | 0,0500 | 0,2500 | 2,0000 | 50,0000 | 1,0000 | 0 | 0 |
| MBR-D | 0,0500 | 0,3800 | 1,0000 | 0,0500 | 0,2500 | 2,0000 | 50,0000 | 1,0000 | 0 | 0 |

| Element name | Surface pressure [kPa] | Fractional effective saturation depth (Fed) [-] |
|--------------|------------------------|---|
| MBR-A | 101,3250 | 0,3000 |
| MBR-B | 101,3250 | 0,3000 |



| | | |
|-------|----------|--------|
| MBR-C | 101,3250 | 0,3000 |
| MBR-D | 101,3250 | 0,3000 |

| Element name | Supply gas CO2 content [vol. %] | Supply gas O2 [vol. %] | Off-gas CO2 [vol. %] | Off-gas O2 [vol. %] | Off-gas H2 [vol. %] | Off-gas NH3 [vol. %] | Off-gas CH4 [vol. %] | Off-gas N2O [vol. %] | Surface turbulence factor [-] |
|--------------|---------------------------------|------------------------|----------------------|---------------------|---------------------|----------------------|----------------------|----------------------|-------------------------------|
| MBR-A | 0,0400 | 20,9500 | 1,2000 | 19,9000 | 0 | 0 | 0 | 0 | 2,0000 |
| MBR-B | 0,0400 | 20,9500 | 1,2000 | 19,9000 | 0 | 0 | 0 | 0 | 2,0000 |
| MBR-C | 0,0400 | 20,9500 | 1,2000 | 19,9000 | 0 | 0 | 0 | 0 | 2,0000 |
| MBR-D | 0,0400 | 20,9500 | 1,2000 | 19,9000 | 0 | 0 | 0 | 0 | 2,0000 |

Configuration information for all Input - SSO units

Operating data Average (flow/time weighted as required)

| Element name | SEPTIC |
|---|--------|
| Biomass - Ordinary heterotrophic [mgCOD/L] | 0 |
| Biomass - Methylothetic [mgCOD/L] | 0 |
| Biomass - Ammonia oxidizing [mgCOD/L] | 0 |
| Biomass - Nitrite oxidizing [mgCOD/L] | 0 |
| Biomass - Anaerobic ammonia oxidizing [mgCOD/L] | 0 |
| Biomass - Phosphorus accumulating [mgCOD/L] | 0 |
| Biomass - Propionic acetogenic [mgCOD/L] | 0 |
| Biomass - Acetoclastic methanogenic [mgCOD/L] | 0 |
| Biomass - Hydrogenotrophic methanogenic [mgCOD/L] | 0 |
| Biomass - Endogenous products [mgCOD/L] | 0 |
| CODp - Slowly degradable particulate [mgCOD/L] | 0 |
| CODp - Slowly degradable colloidal [mgCOD/L] | 0 |



| | |
|--|--------|
| CODp - Degradable external organics [mgCOD/L] | 100,00 |
| CODp - Undegradable non-cellulose [mgCOD/L] | 0 |
| CODp - Undegradable cellulose [mgCOD/L] | 0 |
| N - Particulate degradable organic [mgN/L] | 0 |
| P - Particulate degradable organic [mgP/L] | 0 |
| N - Particulate degradable external organics [mgN/L] | 10,00 |
| P - Particulate degradable external organics [mgP/L] | 5,00 |
| N - Particulate undegradable [mgN/L] | 0 |
| P - Particulate undegradable [mgP/L] | 0 |
| CODp - Stored PHA [mgCOD/L] | 0 |
| P - Releasable stored polyP [mgP/L] | 0 |
| P - Unreleasable stored polyP [mgP/L] | 0 |
| CODs - Complex readily degradable [mgCOD/L] | 0 |
| CODs - Acetate [mgCOD/L] | 0 |
| CODs - Propionate [mgCOD/L] | 0 |
| CODs - Methanol [mgCOD/L] | 0 |
| Gas - Dissolved hydrogen [mgCOD/L] | 0 |
| Gas - Dissolved methane [mg/L] | 0 |
| N - Ammonia [mgN/L] | 0 |
| N - Soluble degradable organic [mgN/L] | 0 |
| Gas - Dissolved nitrous oxide [mgN/L] | 0 |
| N - Nitrite [mgN/L] | 0 |
| N - Nitrate [mgN/L] | 0 |
| Gas - Dissolved nitrogen [mgN/L] | 0 |
| P - Soluble phosphate [mgP/L] | 0 |
| CODs - Undegradable [mgCOD/L] | 0 |
| N - Soluble undegradable organic [mgN/L] | 0 |
| Influent inorganic suspended solids [mgISS/L] | 0 |
| Precipitate - Struvite [mgISS/L] | 0 |
| Precipitate - Brushite [mgISS/L] | 0 |
| Precipitate - Hydroxy - apatite [mgISS/L] | 0 |



| | |
|--|---|
| Precipitate - Vivianite [mgISS/L] | 0 |
| HFO - High surface [mg/L] | 0 |
| HFO - Low surface [mg/L] | 0 |
| HFO - High with H ₂ PO ₄ - adsorbed [mg/L] | 0 |
| HFO - Low with H ₂ PO ₄ - adsorbed [mg/L] | 0 |
| HFO - Aged [mg/L] | 0 |
| HFO - Low with H ⁺ adsorbed [mg/L] | 0 |
| HFO - High with H ⁺ adsorbed [mg/L] | 0 |
| HAO - High surface [mg/L] | 0 |
| HAO - Low surface [mg/L] | 0 |
| HAO - High with H ₂ PO ₄ - adsorbed [mg/L] | 0 |
| HAO - Low with H ₂ PO ₄ - adsorbed [mg/L] | 0 |
| HAO - Aged [mg/L] | 0 |
| P - Bound on aged HMO [mgP/L] | 0 |
| Metal soluble - Magnesium [mg/L] | 0 |
| Metal soluble - Calcium [mg/L] | 0 |
| Metal soluble - Ferric [mg/L] | 0 |
| Metal soluble - Ferrous [mg/L] | 0 |
| Metal soluble - Aluminum [mg/L] | 0 |
| Other Cations (strong bases) [meq/L] | 0 |
| Other Anions (strong acids) [meq/L] | 0 |
| Gas - Dissolved total CO ₂ [mmol/L] | 0 |
| User defined - UD1 [mg/L] | 0 |
| User defined - UD2 [mg/L] | 0 |
| User defined - UD3 [mgVSS/L] | 0 |
| User defined - UD4 [mgISS/L] | 0 |
| Biomass - Sulfur oxidizing [mgCOD/L] | 0 |
| Biomass - Sulfur reducing propionic acetogenic [mgCOD/L] | 0 |
| Biomass - Sulfur reducing acetotrophic [mgCOD/L] | 0 |
| Biomass - Sulfur reducing hydrogenotrophic [mgCOD/L] | 0 |
| Gas - Dissolved total sulfides [mgS/L] | 0 |



| | |
|--|-----|
| S - Soluble sulfate [mgS/L] | 0 |
| S - Particulate elemental sulfur [mgS/L] | 0 |
| Precipitate - Ferrous sulfide [mgSS/L] | 0 |
| CODp - Adsorbed hydrocarbon [mgCOD/L] | 0 |
| CODs - Degradable volatile ind. #1 [mgCOD/L] | 0 |
| CODs - Degradable volatile ind. #2 [mgCOD/L] | 0 |
| CODs - Degradable volatile ind. #3 [mgCOD/L] | 0 |
| CODs - Soluble hydrocarbon [mgCOD/L] | 0 |
| Gas - Dissolved oxygen [mg/L] | 0 |
| Flow | 100 |

Configuration information for all Separator - Grit tank units

Physical data

| Element name | Volume [m3] | Area [m2] | Depth [m] |
|--------------|-------------|-----------|-----------|
| Grit removal | 32,0040 | 12,6000 | 2,540 |

Operating data Average (flow/time weighted as required)

| Element name | Split method | Average Split specification |
|--------------|--------------|-----------------------------|
| Grit removal | Flow paced | 0,02 % |

| Element name | Percent removal | Blanket fraction |
|--------------|-----------------|------------------|
| Grit removal | 5,00 | 0,10 |



Configuration information for all Influent - COD units

Operating data Average (flow/time weighted as required)

| Element name | INF |
|-----------------------------------|---------|
| Flow | 1804,92 |
| COD - Total mgCOD/L | 833,73 |
| N - Total Kjeldahl Nitrogen mgN/L | 97,00 |
| P - Total P mgP/L | 9,87 |
| S - Total S mgS/L | 10,00 |
| N - Nitrate mgN/L | 0,10 |
| pH | 7,90 |
| Alkalinity mmol/L | 7,46 |
| ISS Total mgISS/L | 21,29 |
| Metal soluble - Calcium mg/L | 80,00 |
| Metal soluble - Magnesium mg/L | 15,00 |
| Gas - Dissolved oxygen mg/L | 0,10 |

| Element name | INF |
|---|----------|
| Fbs - Readily biodegradable (including Acetate) [gCOD/g of total COD] | 0,3970 |
| Fac - Acetate [gCOD/g of readily biodegradable COD] | 0,2194 |
| Fxsp - Non-colloidal slowly biodegradable [gCOD/g of slowly degradable COD] | 0,7088 |
| Fus - Unbiodegradable soluble [gCOD/g of total COD] | 0,0383 |
| Fup - Unbiodegradable particulate [gCOD/g of total COD] | 0,1700 |
| Fcel - Cellulose fraction of unbiodegradable particulate [gCOD/gCOD] | 0,4500 |
| Fna - Ammonia [gNH3-N/gTKN] | 0,7921 |
| Fnox - Particulate organic nitrogen [gN/g Organic N] | 0,5000 |
| Fnus - Soluble unbiodegradable TKN [gN/gTKN] | 1,000E-4 |
| FupN - N:COD ratio for unbiodegradable part. COD [gN/gCOD] | 0,0700 |
| Fpo4 - Phosphate [gPO4-P/gTP] | 0,5745 |



| | |
|--|----------|
| FupP - P:COD ratio for unbiodegradable part. COD [gP/gCOD] | 0,0220 |
| Fsr - Reduced sulfur [H2S] [gS/gS] | 0,1500 |
| FZbh - Ordinary heterotrophic COD fraction [gCOD/g of total COD] | 0,0200 |
| FZbm - Methylotrophic COD fraction [gCOD/g of total COD] | 1,000E-4 |
| FZao - Ammonia oxidizing COD fraction [gCOD/g of total COD] | 1,000E-4 |
| FZno - Nitrite oxidizing COD fraction [gCOD/g of total COD] | 1,000E-4 |
| FZaao - Anaerobic ammonia oxidizing COD fraction [gCOD/g of total COD] | 1,000E-4 |
| FZppa - Phosphorus accumulating COD fraction [gCOD/g of total COD] | 1,000E-4 |
| FZpa - Propionic acetogenic COD fraction [gCOD/g of total COD] | 1,000E-4 |
| FZam - Acetoclastic methanogenic COD fraction [gCOD/g of total COD] | 1,000E-4 |
| FZhm - Hydrogenotrophic methanogenic COD fraction [gCOD/g of total COD] | 1,000E-4 |
| FZso - Sulfur oxidizing COD fraction [gCOD/g of total COD] | 1,000E-4 |
| FZsrpa - Sulfur reducing propionic acetogenic COD fraction [gCOD/g of total COD] | 1,000E-4 |
| FZsra - Sulfur reducing acetotrophic COD fraction [gCOD/g of total COD] | 1,000E-4 |
| FZsrh - Sulfur reducing hydrogenotrophic COD fraction [gCOD/g of total COD] | 1,000E-4 |
| FZe - Endogenous products COD fraction [gCOD/g of total COD] | 0 |

Configuration information for all Input - Iron (as ferric chloride) units

Operating data Average (flow/time weighted as required)

| Element name | FeCl3 |
|---|-------|
| Biomass - Ordinary heterotrophic [mgCOD/L] | 0 |
| Biomass - Methylotrophic [mgCOD/L] | 0 |
| Biomass - Ammonia oxidizing [mgCOD/L] | 0 |
| Biomass - Nitrite oxidizing [mgCOD/L] | 0 |
| Biomass - Anaerobic ammonia oxidizing [mgCOD/L] | 0 |
| Biomass - Phosphorus accumulating [mgCOD/L] | 0 |
| Biomass - Propionic acetogenic [mgCOD/L] | 0 |



| | |
|--|---|
| Biomass - Acetoclastic methanogenic [mgCOD/L] | 0 |
| Biomass - Hydrogenotrophic methanogenic [mgCOD/L] | 0 |
| Biomass - Endogenous products [mgCOD/L] | 0 |
| CODp - Slowly degradable particulate [mgCOD/L] | 0 |
| CODp - Slowly degradable colloidal [mgCOD/L] | 0 |
| CODp - Degradable external organics [mgCOD/L] | 0 |
| CODp - Undegradable non-cellulose [mgCOD/L] | 0 |
| CODp - Undegradable cellulose [mgCOD/L] | 0 |
| N - Particulate degradable organic [mgN/L] | 0 |
| P - Particulate degradable organic [mgP/L] | 0 |
| N - Particulate degradable external organics [mgN/L] | 0 |
| P - Particulate degradable external organics [mgP/L] | 0 |
| N - Particulate undegradable [mgN/L] | 0 |
| P - Particulate undegradable [mgP/L] | 0 |
| CODp - Stored PHA [mgCOD/L] | 0 |
| P - Releasable stored polyP [mgP/L] | 0 |
| P - Unreleasable stored polyP [mgP/L] | 0 |
| CODs - Complex readily degradable [mgCOD/L] | 0 |
| CODs - Acetate [mgCOD/L] | 0 |
| CODs - Propionate [mgCOD/L] | 0 |
| CODs - Methanol [mgCOD/L] | 0 |
| Gas - Dissolved hydrogen [mgCOD/L] | 0 |
| Gas - Dissolved methane [mg/L] | 0 |
| N - Ammonia [mgN/L] | 0 |
| N - Soluble degradable organic [mgN/L] | 0 |
| Gas - Dissolved nitrous oxide [mgN/L] | 0 |
| N - Nitrite [mgN/L] | 0 |
| N - Nitrate [mgN/L] | 0 |
| Gas - Dissolved nitrogen [mgN/L] | 0 |
| P - Soluble phosphate [mgP/L] | 0 |
| CODs - Undegradable [mgCOD/L] | 0 |



| | |
|---|-----------|
| N - Soluble undegradable organic [mgN/L] | 0 |
| Influent inorganic suspended solids [mgISS/L] | 0 |
| Precipitate - Struvite [mgISS/L] | 0 |
| Precipitate - Brushite [mgISS/L] | 0 |
| Precipitate - Hydroxy - apatite [mgISS/L] | 0 |
| Precipitate - Vivianite [mgISS/L] | 0 |
| HFO - High surface [mg/L] | 0 |
| HFO - Low surface [mg/L] | 0 |
| HFO - High with H2PO4- adsorbed [mg/L] | 0 |
| HFO - Low with H2PO4- adsorbed [mg/L] | 0 |
| HFO - Aged [mg/L] | 0 |
| HFO - Low with H+ adsorbed [mg/L] | 0 |
| HFO - High with H+ adsorbed [mg/L] | 0 |
| HAO - High surface [mg/L] | 0 |
| HAO - Low surface [mg/L] | 0 |
| HAO - High with H2PO4- adsorbed [mg/L] | 0 |
| HAO - Low with H2PO4- adsorbed [mg/L] | 0 |
| HAO - Aged [mg/L] | 0 |
| P - Bound on aged HMO [mgP/L] | 0 |
| Metal soluble - Magnesium [mg/L] | 0 |
| Metal soluble - Calcium [mg/L] | 0 |
| Metal soluble - Ferric [mg/L] | 150000,00 |
| Metal soluble - Ferrous [mg/L] | 0 |
| Metal soluble - Aluminum [mg/L] | 0 |
| Other Cations (strong bases) [meq/L] | 5,00 |
| Other Anions (strong acids) [meq/L] | 8062,73 |
| Gas - Dissolved total CO2 [mmol/L] | 7,00 |
| User defined - UD1 [mg/L] | 0 |
| User defined - UD2 [mg/L] | 0 |
| User defined - UD3 [mgVSS/L] | 0 |
| User defined - UD4 [mgISS/L] | 0 |



| | |
|--|---------------------|
| Biomass - Sulfur oxidizing [mgCOD/L] | 0 |
| Biomass - Sulfur reducing propionic acetogenic [mgCOD/L] | 0 |
| Biomass - Sulfur reducing acetotrophic [mgCOD/L] | 0 |
| Biomass - Sulfur reducing hydrogenotrophic [mgCOD/L] | 0 |
| Gas - Dissolved total sulfides [mgS/L] | 0 |
| S - Soluble sulfate [mgS/L] | 0 |
| S - Particulate elemental sulfur [mgS/L] | 0 |
| Precipitate - Ferrous sulfide [mgISS/L] | 0 |
| CODp - Adsorbed hydrocarbon [mgCOD/L] | 0 |
| CODs - Degradable volatile ind. #1 [mgCOD/L] | 0 |
| CODs - Degradable volatile ind. #2 [mgCOD/L] | 0 |
| CODs - Degradable volatile ind. #3 [mgCOD/L] | 0 |
| CODs - Soluble hydrocarbon [mgCOD/L] | 0 |
| Gas - Dissolved oxygen [mg/L] | 0 |
| Flow | 1,61487496264569E-8 |

Configuration information for all Separator - Dewatering unit units

Operating data Average (flow/time weighted as required)

| Element name | Split method | Average Split specification |
|--------------|--------------|-----------------------------|
| Compacter1 | Flow paced | 0,01 % |
| Compacter2 | Flow paced | 0,01 % |

| Element name | Percent removal |
|--------------|-----------------|
| Compacter1 | 100,00 |
| Compacter2 | 100,00 |



Configuration information for all Separator - Microscreen units

Operating data Average (flow/time weighted as required)

| Element name | Split method | Average Split specification |
|--------------|--------------|-----------------------------|
| Screen (1mm) | Flow paced | 0,02 % |

| Element name | Percent removal |
|--------------|-----------------|
| Screen (1mm) | 1,00 |

Configuration information for all Separator - Cyclone (dewatering) units

Operating data Average (flow/time weighted as required)

| Element name | Split method | Average Split specification |
|-----------------------|--------------|-----------------------------|
| Dewatering Centrifuge | Fraction | 0,03 |

| Element name | Percent removal |
|-----------------------|-----------------|
| Dewatering Centrifuge | 97,00 |

Configuration information for all Splitter units

Operating data Average (flow/time weighted as required)



| Element name | Split method | Average Split specification |
|-------------------------|-----------------|-----------------------------|
| ANA-R1 | Flowrate [Side] | 2296 |
| ANA-R3 | Flowrate [Side] | 2296 |
| MBR Distributer1 | Fraction | 0,25 |
| AS Emergency Bypass | Bypass | 13200 |
| INF Distributer1 | Fraction | 0,67 |
| Screen Emergency Bypass | Bypass | 13200 |
| ANOX-R2 | Flowrate [Side] | 4866,67 |
| RAS Splitter2 | Fraction | 0,50 |
| WAS Splitter | Flowrate [Side] | 91,66666 |
| RAS Splitter1 | Fraction | 0,33 |
| SCREENING Splitter | Flowrate [Side] | 0 |
| MBR Distributer2 | Fraction | 0,33 |
| INF Distributer2 | Fraction | 0,50 |
| ANOX-R1 | Flowrate [Side] | 4866,67 |
| ANA-R2 | Flowrate [Side] | 2296 |
| ANOX-R3 | Flowrate [Side] | 4866,67 |
| MBR Distributer3 | Fraction | 0,50 |

Configuration information for all Influent - State variable units

Operating data Average (flow/time weighted as required)

| Element name | POLYMER |
|---|---------|
| Biomass - Ordinary heterotrophic [mgCOD/L] | 0 |
| Biomass - Methylothetic [mgCOD/L] | 0 |
| Biomass - Ammonia oxidizing [mgCOD/L] | 0 |
| Biomass - Nitrite oxidizing [mgCOD/L] | 0 |
| Biomass - Anaerobic ammonia oxidizing [mgCOD/L] | 0 |



| | |
|--|----------|
| Biomass - Phosphorus accumulating [mgCOD/L] | 0 |
| Biomass - Propionic acetogenic [mgCOD/L] | 0 |
| Biomass - Acetoclastic methanogenic [mgCOD/L] | 0 |
| Biomass - Hydrogenotrophic methanogenic [mgCOD/L] | 0 |
| Biomass - Endogenous products [mgCOD/L] | 0 |
| CODp - Slowly degradable particulate [mgCOD/L] | 18180,00 |
| CODp - Slowly degradable colloidal [mgCOD/L] | 0 |
| CODp - Degradable external organics [mgCOD/L] | 0 |
| CODp - Undegradable non-cellulose [mgCOD/L] | 0 |
| CODp - Undegradable cellulose [mgCOD/L] | 0 |
| N - Particulate degradable organic [mgN/L] | 0 |
| P - Particulate degradable organic [mgP/L] | 0 |
| N - Particulate degradable external organics [mgN/L] | 0 |
| P - Particulate degradable external organics [mgP/L] | 0 |
| N - Particulate undegradable [mgN/L] | 0 |
| P - Particulate undegradable [mgP/L] | 0 |
| CODp - Stored PHA [mgCOD/L] | 0 |
| P - Releasable stored polyP [mgP/L] | 0 |
| P - Unreleasable stored polyP [mgP/L] | 0 |
| CODs - Complex readily degradable [mgCOD/L] | 0 |
| CODs - Acetate [mgCOD/L] | 0 |
| CODs - Propionate [mgCOD/L] | 0 |
| CODs - Methanol [mgCOD/L] | 0 |
| Gas - Dissolved hydrogen [mgCOD/L] | 0 |
| Gas - Dissolved methane [mg/L] | 0 |
| N - Ammonia [mgN/L] | 0 |
| N - Soluble degradable organic [mgN/L] | 0 |
| Gas - Dissolved nitrous oxide [mgN/L] | 0 |
| N - Nitrite [mgN/L] | 0 |
| N - Nitrate [mgN/L] | 0 |
| Gas - Dissolved nitrogen [mgN/L] | 0 |



| | |
|--|---|
| P - Soluble phosphate [mgP/L] | 0 |
| CODs - Undegradable [mgCOD/L] | 0 |
| N - Soluble undegradable organic [mgN/L] | 0 |
| Influent inorganic suspended solids [mgISS/L] | 0 |
| Precipitate - Struvite [mgISS/L] | 0 |
| Precipitate - Brushite [mgISS/L] | 0 |
| Precipitate - Hydroxy - apatite [mgISS/L] | 0 |
| Precipitate - Vivianite [mgISS/L] | 0 |
| HFO - High surface [mg/L] | 0 |
| HFO - Low surface [mg/L] | 0 |
| HFO - High with H ₂ PO ₄ - adsorbed [mg/L] | 0 |
| HFO - Low with H ₂ PO ₄ - adsorbed [mg/L] | 0 |
| HFO - Aged [mg/L] | 0 |
| HFO - Low with H ⁺ adsorbed [mg/L] | 0 |
| HFO - High with H ⁺ adsorbed [mg/L] | 0 |
| HAO - High surface [mg/L] | 0 |
| HAO - Low surface [mg/L] | 0 |
| HAO - High with H ₂ PO ₄ - adsorbed [mg/L] | 0 |
| HAO - Low with H ₂ PO ₄ - adsorbed [mg/L] | 0 |
| HAO - Aged [mg/L] | 0 |
| P - Bound on aged HMO [mgP/L] | 0 |
| Metal soluble - Magnesium [mg/L] | 0 |
| Metal soluble - Calcium [mg/L] | 0 |
| Metal soluble - Ferric [mg/L] | 0 |
| Metal soluble - Ferrous [mg/L] | 0 |
| Metal soluble - Aluminum [mg/L] | 0 |
| Other Cations (strong bases) [meq/L] | 0 |
| Other Anions (strong acids) [meq/L] | 0 |
| Gas - Dissolved total CO ₂ [mmol/L] | 0 |
| User defined - UD1 [mg/L] | 0 |
| User defined - UD2 [mg/L] | 0 |



| | |
|--|----------------------|
| User defined - UD3 [mgVSS/L] | 0 |
| User defined - UD4 [mgISS/L] | 0 |
| Biomass - Sulfur oxidizing [mgCOD/L] | 0 |
| Biomass - Sulfur reducing propionic acetogenic [mgCOD/L] | 0 |
| Biomass - Sulfur reducing acetotrophic [mgCOD/L] | 0 |
| Biomass - Sulfur reducing hydrogenotrophic [mgCOD/L] | 0 |
| Gas - Dissolved total sulfides [mgS/L] | 0 |
| S - Soluble sulfate [mgS/L] | 0 |
| S - Particulate elemental sulfur [mgS/L] | 0 |
| Precipitate - Ferrous sulfide [mgISS/L] | 0 |
| CODp - Adsorbed hydrocarbon [mgCOD/L] | 0 |
| CODs - Degradable volatile ind. #1 [mgCOD/L] | 0 |
| CODs - Degradable volatile ind. #2 [mgCOD/L] | 0 |
| CODs - Degradable volatile ind. #3 [mgCOD/L] | 0 |
| CODs - Soluble hydrocarbon [mgCOD/L] | 0 |
| Gas - Dissolved oxygen [mg/L] | 0 |
| Flow | 7,35134605098841E-12 |

Configuration information for all Equalization Tank units

Physical data

| Element name | Volume[m3] | Area[m2] | Depth[m] |
|--------------|------------|----------|----------|
| EFF Storage | 1000,0000 | 190,4762 | 5,250 |
| Drainage | 27,0000 | 9,0000 | 3,000 |

BioWin Album

Album page - Loads Overview



| Elements | Flow [m3/d] | Total suspended solids [kg /d] | Volatile suspended solids [kg /d] | ISS Total [kg /d] | BOD - Total Carbonaceous [kg /d] | COD - Total [kg /d] | N - Total N [kg N/d] | P - Total P [kg P/d] |
|-----------------------|-------------|--------------------------------|-----------------------------------|-------------------|----------------------------------|---------------------|----------------------|----------------------|
| INF | 1956,00 | 304,63 | 285,07 | 19,56 | 391,85 | 846,95 | 175,84 | 16,82 |
| SEPTIC | 100,00 | 6,25 | 6,25 | 0 | 5,71 | 10,00 | 1,00 | 0,50 |
| GRIT | 0,07 | 0,36 | 0,02 | 0,34 | 0,03 | 0,06 | 0,01 | 0,00 |
| SCREENING | 0,20 | 3,55 | 3,52 | 0,03 | 0,35 | 4,63 | 0,20 | 0,06 |
| G | | | | | | | | |
| Dewatering Centrifuge | 0,00 | 0 | 0 | 0 | 0 | 0 | 0 | 0 |
| Screen (1mm) | 459,61 | 74,76 | 72,04 | 2,72 | 101,02 | 212,47 | 36,62 | 3,20 |
| ANA-1 | 2449,29 | 11370,88 | 9720,35 | 1650,54 | 3305,84 | 13411,92 | 791,57 | 378,06 |
| ANOX-1 | 7315,96 | 37297,88 | 31786,85 | 5511,03 | 10695,30 | 43710,49 | 2538,78 | 1238,33 |
| AT-1A | 17192,71 | 91668,83 | 77809,74 | 13859,09 | 26125,02 | 106955,27 | 6166,47 | 3037,19 |
| AT-1B | 17192,71 | 91836,89 | 77909,03 | 13927,86 | 26154,55 | 107091,46 | 6167,21 | 3041,53 |
| Collect Distribute | 51559,94 | 275460,92 | 233689,76 | 41771,16 | 78448,54 | 321219,43 | 18497,95 | 9123,04 |
| MBR-A | 114,98 | 0 | 0 | 0 | 0,13 | 4,95 | 0,34 | 0,08 |
| EFF Storage | 459,93 | 0 | 0 | 0 | 0,56 | 19,36 | 2,50 | 0,20 |
| EFF | 459,93 | 0,00 | 0,00 | 0,00 | 0,56 | 19,36 | 2,50 | 0,20 |
| RAS Pit | 36500,00 | 197782,22 | 167605,20 | 30177,03 | 56263,01 | 230403,71 | 13258,74 | 6547,96 |
| WAS Tank | 0,00 | 0,00 | 0,00 | 0,00 | 0,00 | 0,00 | 0,00 | 0,00 |
| Dewatered Sludge | 0 | 0 | 0 | 0 | 0 | 0 | 0 | 0 |
| FeCl3 | 0,00 | 0 | 0 | 0 | 0 | 0 | 0 | 0 |
| POLYMER | 0,00 | 0,00 | 0,00 | 0,00 | 0,00 | 0,00 | 0 | 0 |

Album page - Loads

| Elements | INF | SEPTIC | GRIT | SCREENING | EFF | Dewatered Sludge | FeCl3 | POLYMER |
|----------|-----|--------|------|-----------|-----|------------------|-------|---------|
|----------|-----|--------|------|-----------|-----|------------------|-------|---------|



| | | | | | | | | |
|-----------------------------------|---------|--------|------|------|--------|---|------|------|
| Flow [m3/d] | 1956,00 | 100,00 | 0,07 | 0,20 | 459,93 | 0 | 0,00 | 0,00 |
| Total suspended solids [kg /d] | 304,63 | 6,25 | 0,36 | 3,55 | 0,00 | 0 | 0 | 0,00 |
| Volatile suspended solids [kg /d] | 285,07 | 6,25 | 0,02 | 3,52 | 0,00 | 0 | 0 | 0,00 |
| ISS Total [kg /d] | 19,56 | 0 | 0,34 | 0,03 | 0,00 | 0 | 0 | 0,00 |
| BOD - Total Carbonaceous [kg /d] | 391,85 | 5,71 | 0,03 | 0,35 | 0,56 | 0 | 0 | 0,00 |
| COD - Total [kg /d] | 846,95 | 10,00 | 0,06 | 4,63 | 19,36 | 0 | 0 | 0,00 |
| N - Total N [kg N/d] | 175,84 | 1,00 | 0,01 | 0,20 | 2,50 | 0 | 0 | 0 |
| P - Total P [kg P/d] | 16,82 | 0,50 | 0,00 | 0,06 | 0,20 | 0 | 0 | 0 |
| Total iron (all forms) [kg Me/d] | 0 | 0 | 0,00 | 0,00 | 0,00 | 0 | 0,00 | 0 |

Album page - Concentration Overview

| Elements | Flow [m3/d] | Total suspended solids [mg/L] | Volatile suspended solids [mg/L] | ISS Total [mg/L] | BOD - Total Carbonaceous [mg/L] | COD - Total [mg/L] | N - Total N [mgN/L] | P - Total P [mgP/L] |
|-----------------------|-------------|-------------------------------|----------------------------------|------------------|---------------------------------|--------------------|---------------------|---------------------|
| INF | 1956,00 | 155,74 | 145,74 | 10,00 | 200,33 | 433,00 | 89,90 | 8,60 |
| SEPTIC | 100,00 | 62,50 | 62,50 | 0 | 57,11 | 100,00 | 10,00 | 5,00 |
| GRIT | 0,07 | 4944,65 | 270,61 | 4674,05 | 370,51 | 799,58 | 92,49 | 9,62 |
| SCREENIN G | 0,20 | 18134,03 | 17993,55 | 140,48 | 1796,45 | 23668,58 | 1043,65 | 306,36 |
| Dewatering Centrifuge | 0,00 | 0 | 0 | 0 | 0 | 0 | 0 | 0 |
| Screen (1mm) | 459,61 | 162,66 | 156,74 | 5,92 | 219,80 | 462,28 | 79,68 | 6,96 |
| ANA-1 | 2449,29 | 4642,51 | 3968,63 | 673,88 | 1349,71 | 5475,83 | 323,18 | 154,35 |
| ANOX-1 | 7315,96 | 5098,15 | 4344,86 | 753,29 | 1461,91 | 5974,67 | 347,02 | 169,26 |
| AT-1A | 17192,71 | 5331,84 | 4525,74 | 806,10 | 1519,54 | 6220,97 | 358,67 | 176,66 |
| AT-1B | 17192,71 | 5341,62 | 4531,51 | 810,10 | 1521,26 | 6228,89 | 358,71 | 176,91 |



| | | | | | | | | |
|---------------------|----------|----------|----------|--------|---------|----------|--------|--------|
| Collect | 51559,94 | 5342,54 | 4532,39 | 810,15 | 1521,50 | 6230,02 | 358,77 | 176,94 |
| Distribute | | | | | | | | |
| MBR-A | 114,98 | 0 | 0 | 0 | 1,13 | 43,07 | 2,97 | 0,72 |
| EFF Storage | 459,93 | 0 | 0 | 0 | 1,22 | 42,09 | 5,44 | 0,44 |
| EFF | 459,93 | 0,00 | 0,00 | 0,00 | 1,22 | 42,09 | 5,44 | 0,44 |
| RAS Pit | 36500,00 | 5418,69 | 4591,92 | 826,77 | 1541,45 | 6312,43 | 363,25 | 179,40 |
| WAS Tank | 0,00 | 5888,84 | 5021,83 | 867,02 | 1653,76 | 6897,63 | 402,51 | 198,39 |
| Dewatered Sludge | 0 | 0 | 0 | 0 | 0 | 0 | 0 | 0 |
| FeCl3 | 0,00 | 0 | 0 | 0 | 0 | 0 | 0 | 0 |
| POLYMER | 0,00 | 13063,56 | 12985,71 | 77,85 | 8170,53 | 18180,00 | 0 | 0 |

Album page - Concentration

| Element | INF | SEPTIC | GRIT | Dewatering Centrifuge | SCREE NING | ANA-1 | ANOX-1 | AT-1B | Collect Distribute | EFF | RAS Pit | Dewatered Sludge |
|---|---------|--------|---------|--------------------------|---------------|---------|---------|---------|-----------------------|--------|---------|---------------------|
| Flow [m3/d] | 1956,00 | 100,00 | 0,07 | 0,00 | 0,20 | 2449,29 | 7315,96 | 17192,7 | 51559,9 | 459,93 | 36500,0 | 0 |
| Total suspended solids [mg/L] | 155,74 | 62,50 | 4944,65 | 0 | 18134,0 | 4642,51 | 5098,15 | 5341,62 | 5342,54 | 0,00 | 5418,69 | 0 |
| Volatile suspended solids [mg/L] | 145,74 | 62,50 | 270,61 | 0 | 17993,5 | 3968,63 | 4344,86 | 4531,51 | 4532,39 | 0,00 | 4591,92 | 0 |
| ISS Total [mg/L] | 10,00 | 0 | 4674,05 | 0 | 140,48 | 673,88 | 753,29 | 810,10 | 810,15 | 0,00 | 826,77 | 0 |
| BOD - Total | 200,33 | 57,11 | 370,51 | 0 | 1796,45 | 1349,71 | 1461,91 | 1521,26 | 1521,50 | 1,22 | 1541,45 | 0 |



| | | | | | | | | | | | | | |
|-----------------------------|--------|--------|--------|---|----------|---------|---------|---------|---------|-------|---------|---|--|
| Carbonaceous | | | | | | | | | | | | | |
| [mg/L] | | | | | | | | | | | | | |
| BOD - Filtered | 143,68 | 0 | 263,61 | 0 | 150,45 | 12,70 | 1,03 | 0,28 | 0,24 | 1,22 | 1,01 | 0 | |
| Carbonaceous | | | | | | | | | | | | | |
| [mg/L] | | | | | | | | | | | | | |
| COD - Total | 433,00 | 100,00 | 799,58 | 0 | 23668,58 | 5475,83 | 5974,67 | 6228,89 | 6230,02 | 42,09 | 6312,43 | 0 | |
| [mg/L] | | | | | | | | | | | | | |
| COD - Particulate | 197,42 | 100,00 | 367,36 | 0 | 23421,90 | 5418,93 | 5932,47 | 6187,09 | 6188,28 | 0,00 | 6269,49 | 0 | |
| [mg/L] | | | | | | | | | | | | | |
| COD - Filtered | 235,58 | 0 | 432,22 | 0 | 246,68 | 56,90 | 42,20 | 41,80 | 41,74 | 42,09 | 42,94 | 0 | |
| [mg/L] | | | | | | | | | | | | | |
| N - Total N | 89,90 | 10,00 | 92,49 | 0 | 1043,65 | 323,18 | 347,02 | 358,71 | 358,77 | 5,44 | 363,25 | 0 | |
| [mgN/L] | | | | | | | | | | | | | |
| N - Total Kjeldahl Nitrogen | 89,80 | 10,00 | 92,31 | 0 | 1043,57 | 323,18 | 347,02 | 358,69 | 358,76 | 3,86 | 362,76 | 0 | |
| [mgN/L] | | | | | | | | | | | | | |
| N - Particulate TKN | 11,07 | 10,00 | 13,25 | 0 | 975,37 | 309,21 | 339,69 | 355,46 | 355,53 | 0,00 | 360,55 | 0 | |
| [mgN/L] | | | | | | | | | | | | | |
| N - Ammonia | 71,13 | 0 | 72,71 | 0 | 61,89 | 13,28 | 6,61 | 2,43 | 2,44 | 2,78 | 1,21 | 0 | |
| [mgN/L] | | | | | | | | | | | | | |
| N - Nitrate | 0,10 | 0 | 0,17 | 0 | 0,08 | 0,00 | 0,00 | 0,00 | 0,00 | 1,16 | 0,31 | 0 | |
| [mgN/L] | | | | | | | | | | | | | |



| | | | | | | | | | | | | |
|---------------------------|------|------|------|---|--------|--------|--------|--------|--------|------|--------|---|
| N - Nitrite [mgN/L] | 0 | 0 | 0,00 | 0 | 0,00 | 0,00 | 0,00 | 0,02 | 0,00 | 0,42 | 0,18 | 0 |
| P - Total P [mgP/L] | 8,60 | 5,00 | 9,62 | 0 | 306,36 | 154,35 | 169,26 | 176,91 | 176,94 | 0,44 | 179,40 | 0 |
| P - Soluble PO4-P [mgP/L] | 4,94 | 0 | 5,38 | 0 | 3,53 | 12,79 | 9,49 | 2,05 | 2,09 | 0,44 | 0,29 | 0 |

Album page - Conversions

| Elements | Nit - Ammonia removal rate [kg/d] | Denit - Nitrate removal rate [kg/d] | OTR [kg/d] | OUR - Carbonaceous [kg/d] | OUR - Nitrification [kg/d] | OUR - Sulfur [kg/d] | OUR - Total [kg/d] | SOTR [kg/d] |
|--------------------|-----------------------------------|-------------------------------------|------------|---------------------------|----------------------------|---------------------|--------------------|-------------|
| Septic Tank | 0 | 0 | 0 | 0 | 0 | 0 | 0 | 0 |
| ANA-1 | 0,00 | 0,01 | 0 | 0,00 | 0,00 | 0,01 | 0,01 | 0 |
| ANA-2 | 0,00 | 0,01 | 0 | 0,00 | 0,00 | 0,01 | 0,01 | 0 |
| ANA-3 | 0,00 | 0,01 | 0 | 0,00 | 0,00 | 0,01 | 0,01 | 0 |
| ANOX-1 | 0,00 | 0,00 | 0 | 0,00 | 0,00 | 0,01 | 0,01 | 0 |
| ANOX-2 | 0,00 | 0,00 | 0 | 0,00 | 0,00 | 0,01 | 0,01 | 0 |
| ANOX-3 | 0,00 | 0,00 | 0 | 0,00 | 0,00 | 0,01 | 0,01 | 0 |
| AT-1A | 0,75 | 3,68 | 0 | 0,49 | 2,43 | 9,41 | 12,33 | 0 |
| AT-1B | 10,10 | 0,62 | 88,94 | 7,94 | 33,31 | 46,62 | 87,87 | 217,45 |
| AT-2A | 0,75 | 3,68 | 0 | 0,49 | 2,43 | 9,41 | 12,33 | 0 |
| AT-2B | 10,10 | 0,62 | 88,94 | 7,94 | 33,31 | 46,62 | 87,87 | 217,45 |
| AT-3A | 0,75 | 3,67 | 0 | 0,49 | 2,42 | 9,40 | 12,32 | 0 |
| AT-3B | 10,10 | 0,61 | 88,94 | 7,94 | 33,31 | 46,63 | 87,87 | 217,45 |
| Collect Distribute | 0,29 | 0,09 | 0 | 0,19 | 0,94 | 1,96 | 3,09 | 0 |
| MBR-A | 7,16 | 2,04 | 101,66 | 24,21 | 28,45 | 16,95 | 69,61 | 413,08 |



| | | | | | | | | |
|----------|-------|-------|--------|--------|--------|--------|--------|---------|
| MBR-B | 7,16 | 2,04 | 101,66 | 24,21 | 28,45 | 16,95 | 69,61 | 413,08 |
| MBR-C | 7,16 | 2,04 | 101,66 | 24,21 | 28,45 | 16,95 | 69,61 | 413,08 |
| MBR-D | 7,16 | 2,04 | 101,66 | 24,21 | 28,45 | 16,95 | 69,61 | 413,08 |
| RAS Pit | 9,93 | 6,72 | 0 | 26,25 | 38,98 | 23,25 | 88,48 | 0 |
| WAS Tank | 0 | 0 | 0 | 0 | 0 | 0 | 0 | 0 |
| | ----- | ----- | ----- | ----- | ----- | ----- | ----- | ----- |
| Total | 71,41 | 27,88 | 673,46 | 148,57 | 260,96 | 261,15 | 670,68 | 2304,68 |

Album page - Page 6

Album page - Page 7

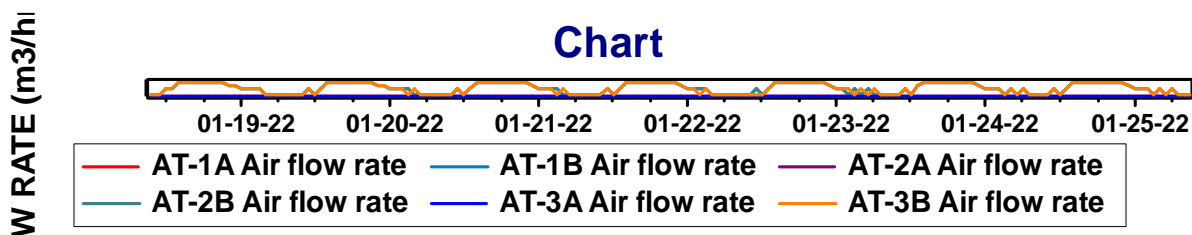

Album page - Page 7

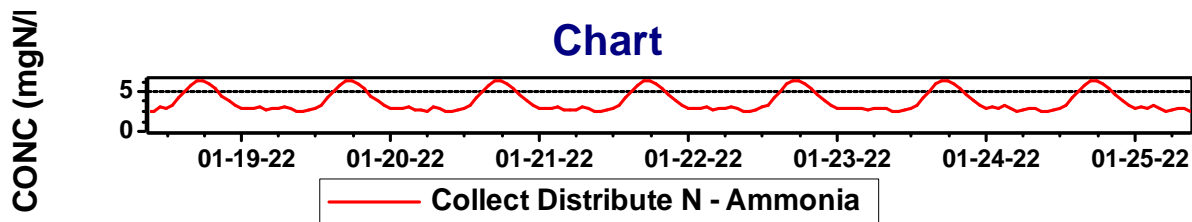

Album page - Page 7



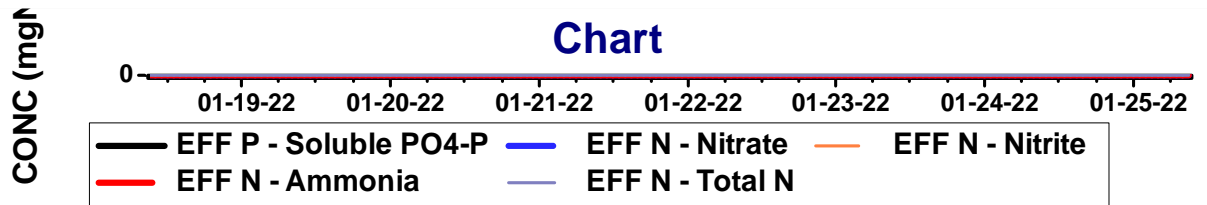

Album page - Page 8

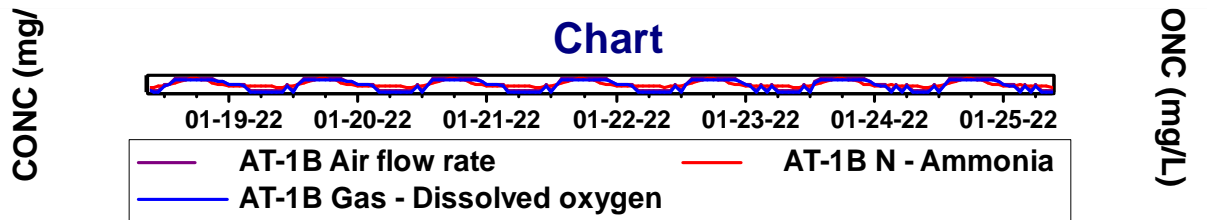

Album page - Page 8

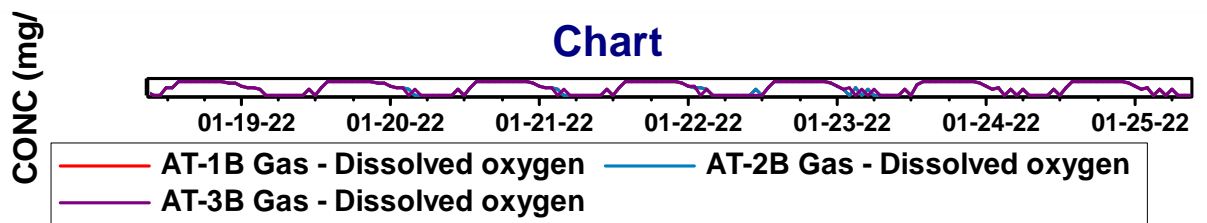

Album page - Page 8

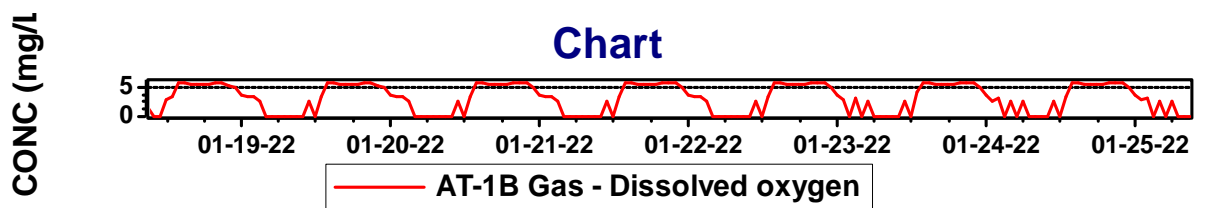

Album page - Page 9

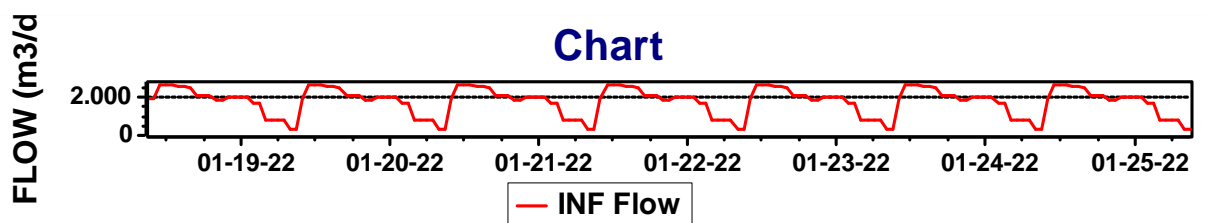

Album page - Page 9

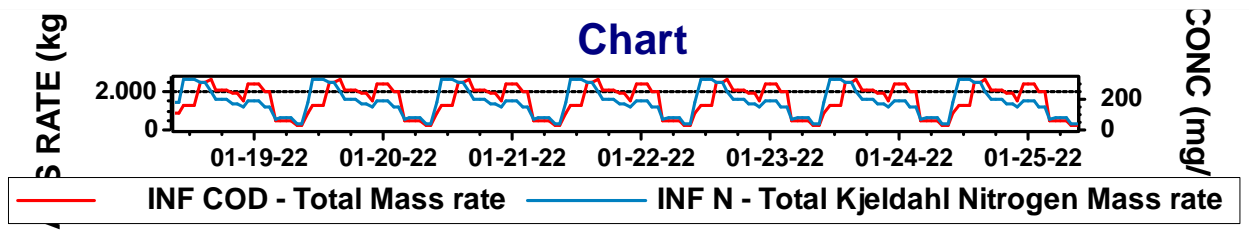

Album page - Page 9

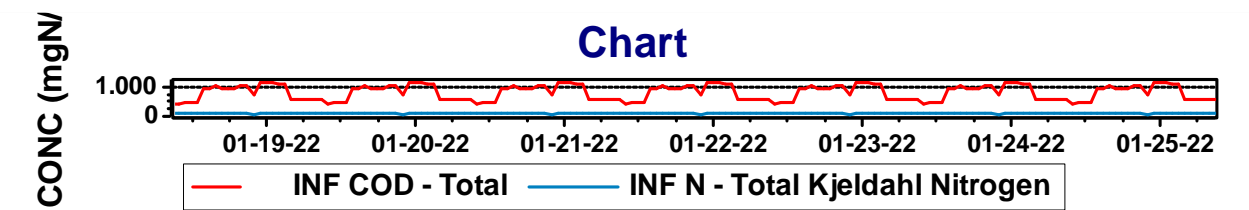

Album page - Page 10

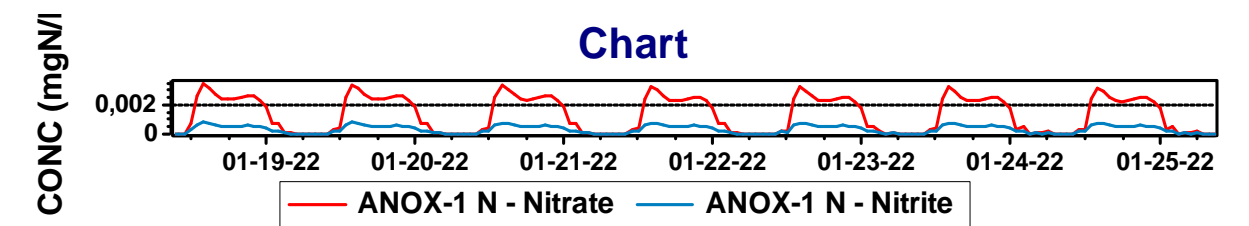

Album page - Page 10

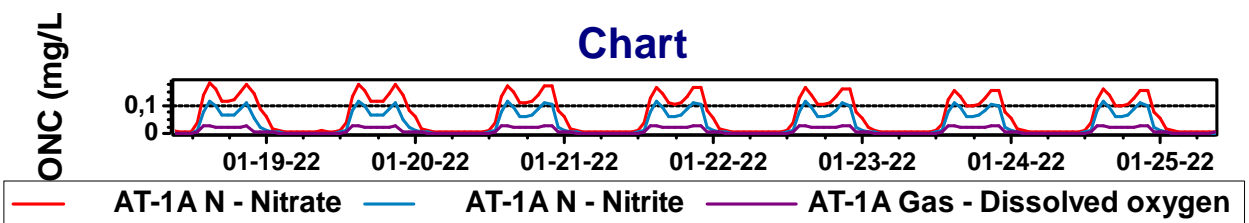

Album page - Page 10



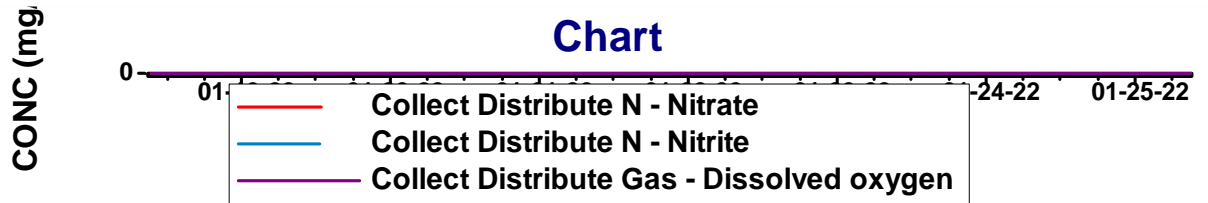

Global Parameters

Common

| Name | Default | Value | |
|---|---------|--------|--------|
| Hydrolysis rate [1/d] | 2,1000 | 2,1000 | 1,0290 |
| Hydrolysis half sat. [-] | 0,0600 | 0,0600 | 1,0000 |
| External organics hydrolysis rate [1/d] | 2,1000 | 2,1000 | 1,0290 |
| External organics hydrolysis half sat. [-] | 0,0600 | 0,0600 | 1,0000 |
| Anoxic hydrolysis factor [-] | 0,2800 | 0,2800 | 1,0000 |
| Anaerobic hydrolysis factor (AS) [-] | 0,0400 | 0,0400 | 1,0000 |
| Anaerobic hydrolysis factor (AD) [-] | 0,5000 | 0,5000 | 1,0000 |
| Adsorption rate of colloids [L/(mgCOD d)] | 0,1500 | 0,1500 | 1,0290 |
| Ammonification rate [L/(mgCOD d)] | 0,0800 | 0,0800 | 1,0290 |
| Assimilative nitrate/nitrite reduction rate [1/d] | 0,5000 | 0,5000 | 1,0000 |
| Endogenous products decay rate [1/d] | 0 | 0 | 1,0000 |

Ammonia oxidizing

| Name | Default | Value | |
|--|---------|---------|--------|
| Max. spec. growth rate [1/d] | 0,9000 | 0,9000 | 1,0720 |
| Substrate (NH4) half sat. [mgN/L] | 0,7000 | 0,7000 | 1,0000 |
| Byproduct NH4 logistic slope [-] | 50,0000 | 50,0000 | 1,0000 |
| Byproduct NH4 inflection point [mgN/L] | 1,4000 | 1,4000 | 1,0000 |
| Denite DO half sat. [mg/L] | 0,1000 | 0,1000 | 1,0000 |



| | | | |
|-----------------------------------|----------|----------|--------|
| Denite HNO2 half sat. [mgN/L] | 5,000E-6 | 5,000E-6 | 1,0000 |
| Aerobic decay rate [1/d] | 0,1700 | 0,1700 | 1,0290 |
| Anoxic/anaerobic decay rate [1/d] | 0,0800 | 0,0800 | 1,0290 |
| KiHNO2 [mmol/L] | 5,000E-3 | 5,000E-3 | 1,0000 |

Nitrite oxidizing

| Name | Default | Value | |
|-----------------------------------|---------|--------|--------|
| Max. spec. growth rate [1/d] | 0,7000 | 1,0000 | 1,0600 |
| Substrate (NO2) half sat. [mgN/L] | 0,1000 | 0,1000 | 1,0000 |
| Aerobic decay rate [1/d] | 0,1700 | 0,1700 | 1,0290 |
| Anoxic/anaerobic decay rate [1/d] | 0,0800 | 0,0800 | 1,0290 |
| KiNH3 [mmol/L] | 0,0750 | 0,0750 | 1,0000 |

Anaerobic ammonia oxidizing

| Name | Default | Value | |
|---|-----------|-----------|--------|
| Max. spec. growth rate [1/d] | 0,2000 | 0,2000 | 1,1000 |
| Substrate (NH4) half sat. [mgN/L] | 2,0000 | 2,0000 | 1,0000 |
| Substrate (NO2) half sat. [mgN/L] | 1,0000 | 1,0000 | 1,0000 |
| Aerobic decay rate [1/d] | 0,0190 | 0,0190 | 1,0290 |
| Anoxic/anaerobic decay rate [1/d] | 9,500E-3 | 9,500E-3 | 1,0290 |
| Ki Nitrite [mgN/L] | 1000,0000 | 1000,0000 | 1,0000 |
| Nitrite sensitivity constant [L / (d mgN)] | 0,0160 | 0,0160 | 1,0000 |

Ordinary heterotrophic

| Name | Default | Value |
|------|---------|-------|
|------|---------|-------|



| | | | |
|--------------------------------------|----------|----------|--------|
| Max. spec. growth rate [1/d] | 3,2000 | 3,2000 | 1,0290 |
| Substrate half sat. [mgCOD/L] | 5,0000 | 5,0000 | 1,0000 |
| Anoxic growth factor [-] | 0,5000 | 1,0000 | 1,0000 |
| Denite N2 producers (NO3 or NO2) [-] | 0,5000 | 0,5000 | 1,0000 |
| Aerobic decay rate [1/d] | 0,6200 | 0,6200 | 1,0290 |
| Anoxic decay rate [1/d] | 0,2330 | 0,2330 | 1,0290 |
| Anaerobic decay rate [1/d] | 0,1310 | 0,1310 | 1,0290 |
| Fermentation rate [1/d] | 1,6000 | 1,6000 | 1,0290 |
| Fermentation half sat. [mgCOD/L] | 5,0000 | 5,0000 | 1,0000 |
| Fermentation growth factor (AS) [-] | 0,2500 | 0,2500 | 1,0000 |
| Free nitrous acid inhibition [mol/L] | 1,000E-7 | 1,000E-7 | 1,0000 |

Heterotrophic on industrial COD

| Name | Default | Value | |
|--|-----------|-----------|--------|
| Maximum specific growth rate on Ind #1 COD [1/d] | 4,3000 | 4,3000 | 1,0290 |
| Substrate (Ind #1) half sat. [mgCOD/L] | 1,0000 | 1,0000 | 1,0000 |
| Inhibition coefficient for Ind #1 [mgCOD/L] | 60,0000 | 60,0000 | 1,0000 |
| Anaerobic growth factor for Ind #1 [mgCOD/L] | 0,0500 | 0,0500 | 1,0000 |
| Maximum specific growth rate on Ind #2 COD [1/d] | 1,5000 | 1,5000 | 1,0290 |
| Substrate (Ind #2) half sat. [mgCOD/L] | 30,0000 | 30,0000 | 1,0000 |
| Inhibition coefficient for Ind #2 [mgCOD/L] | 3000,0000 | 3000,0000 | 1,0000 |
| Anaerobic growth factor for Ind #2 [mgCOD/L] | 0,0500 | 0,0500 | 1,0000 |
| Maximum specific growth rate on Ind #3 COD [1/d] | 4,3000 | 4,3000 | 1,0290 |
| Substrate (Ind #3) half sat. [mgCOD/L] | 1,0000 | 1,0000 | 1,0000 |
| Inhibition coefficient for Ind #3 COD [mgCOD/L] | 60,0000 | 60,0000 | 1,0000 |
| Anaerobic growth factor for Ind #3 [mgCOD/L] | 0,0500 | 0,0500 | 1,0000 |
| Maximum specific growth rate on adsorbed hydrocarbon COD [1/d] | 2,0000 | 2,0000 | 1,0290 |
| Substrate (adsorbed hydrocarbon) half sat. [-] | 0,1500 | 0,1500 | 1,0000 |
| Anaerobic growth factor for adsorbed hydrocarbons [mgCOD/L] | 0,0100 | 0,0100 | 1,0000 |



| | | | |
|---|--------|--------|--------|
| Adsorption rate of soluble hydrocarbons [l/(mgCOD d)] | 0,2000 | 0,2000 | 1,0000 |
|---|--------|--------|--------|

Methylotrophic

| Name | Default | Value | |
|---------------------------------------|----------|----------|--------|
| Max. spec. growth rate [1/d] | 1,3000 | 1,3000 | 1,0720 |
| Methanol half sat. [mgCOD/L] | 0,5000 | 0,5000 | 1,0000 |
| Denite N2 producers (NO3 or NO2) [-] | 0,5000 | 0,5000 | 1,0000 |
| Aerobic decay rate [1/d] | 0,0400 | 0,0400 | 1,0290 |
| Anoxic/anaerobic decay rate [1/d] | 0,0300 | 0,0300 | 1,0290 |
| Free nitrous acid inhibition [mmol/L] | 1,000E-7 | 1,000E-7 | 1,0000 |

Phosphorus accumulating

| Name | Default | Value | |
|--|---------|--------|--------|
| Max. spec. growth rate [1/d] | 0,9500 | 0,9500 | 1,0000 |
| Max. spec. growth rate, P-limited [1/d] | 0,4200 | 0,4200 | 1,0000 |
| Substrate half sat. [mgCOD(PHB)/mgCOD(Zbp)] | 0,1000 | 0,1000 | 1,0000 |
| Substrate half sat., P-limited [mgCOD(PHB)/mgCOD(Zbp)] | 0,0500 | 0,0500 | 1,0000 |
| Magnesium half sat. [mgMg/L] | 0,1000 | 0,1000 | 1,0000 |
| Cation half sat. [mmol/L] | 0,1000 | 0,1000 | 1,0000 |
| Calcium half sat. [mgCa/L] | 0,1000 | 0,1000 | 1,0000 |
| Aerobic/anoxic decay rate [1/d] | 0,1000 | 0,1000 | 1,0000 |
| Aerobic/anoxic maintenance rate [1/d] | 0 | 0 | 1,0000 |
| Anaerobic decay rate [1/d] | 0,0400 | 0,0400 | 1,0000 |
| Anaerobic maintenance rate [1/d] | 0 | 0 | 1,0000 |
| Sequestration rate [1/d] | 4,5000 | 4,5000 | 1,0000 |
| Anoxic growth factor [-] | 0,3300 | 1,0000 | 1,0000 |



Propionic acetogenic

| Name | Default | Value | |
|---------------------------------|------------|------------|--------|
| Max. spec. growth rate [1/d] | 0,2500 | 0,2500 | 1,0290 |
| Substrate half sat. [mgCOD/L] | 10,0000 | 10,0000 | 1,0000 |
| Acetate inhibition [mgCOD/L] | 10000,0000 | 10000,0000 | 1,0000 |
| Anaerobic decay rate [1/d] | 0,0500 | 0,0500 | 1,0290 |
| Aerobic/anoxic decay rate [1/d] | 0,5200 | 0,5200 | 1,0290 |

Methanogenic

| Name | Default | Value | |
|--|------------|------------|--------|
| Acetoclastic max. spec. growth rate [1/d] | 0,3000 | 0,3000 | 1,0290 |
| H ₂ -utilizing max. spec. growth rate [1/d] | 1,4000 | 1,4000 | 1,0290 |
| Acetoclastic substrate half sat. [mgCOD/L] | 100,0000 | 100,0000 | 1,0000 |
| Acetoclastic methanol half sat. [mgCOD/L] | 0,5000 | 0,5000 | 1,0000 |
| H ₂ -utilizing CO ₂ half sat. [mmol/L] | 0,1000 | 0,1000 | 1,0000 |
| H ₂ -utilizing substrate half sat. [mgCOD/L] | 1,0000 | 1,0000 | 1,0000 |
| H ₂ -utilizing methanol half sat. [mgCOD/L] | 0,5000 | 0,5000 | 1,0000 |
| Acetoclastic propionic inhibition [mgCOD/L] | 10000,0000 | 10000,0000 | 1,0000 |
| Acetoclastic anaerobic decay rate [1/d] | 0,1300 | 0,1300 | 1,0290 |
| Acetoclastic aerobic/anoxic decay rate [1/d] | 0,6000 | 0,6000 | 1,0290 |
| H ₂ -utilizing anaerobic decay rate [1/d] | 0,1300 | 0,1300 | 1,0290 |
| H ₂ -utilizing aerobic/anoxic decay rate [1/d] | 2,8000 | 2,8000 | 1,0290 |

Sulfur oxidizing

| Name | Default | Value |
|------|---------|-------|
|------|---------|-------|



| | | | |
|--|--------|--------|--------|
| Maximum specific growth rate (sulfide) [1/d] | 0,7500 | 0,7500 | 1,0290 |
| Maximum specific growth rate (sulfur) [1/d] | 0,1000 | 0,1000 | 1,0290 |
| Substrate (H2S) half sat. [mgS/L] | 1,0000 | 1,0000 | 1,0000 |
| Substrate (sulfur) half sat. [mgS/L] | 1,0000 | 1,0000 | 1,0000 |
| Anoxic growth factor [-] | 0,5000 | 0,5000 | 1,0000 |
| Decay rate [1/d] | 0,0400 | 0,0400 | 1,0290 |

Sulfur reducing

| Name | Default | Value | |
|---|----------|----------|--------|
| Propionic max. spec. growth rate [1/d] | 0,5830 | 0,5830 | 1,0350 |
| Propionic acid half sat. [mgCOD/L] | 295,0000 | 295,0000 | 1,0000 |
| Hydrogen sulfide inhibition coefficient [mgS/L] | 185,0000 | 185,0000 | 1,0000 |
| Sulfate (SO4=) half sat. [mgS/L] | 2,4700 | 2,4700 | 1,0000 |
| Decay rate [1/d] | 0,0185 | 0,0185 | 1,0350 |
| Acetotrophic max. spec. growth rate [1/d] | 0,6120 | 0,6120 | 1,0350 |
| Acetic acid half sat. [mgCOD/L] | 24,0000 | 24,0000 | 1,0000 |
| Hydrogen sulfide inhibition coefficient [mgS/L] | 164,0000 | 164,0000 | 1,0000 |
| Sulfate (SO4=) half sat. [mgS/L] | 6,4100 | 6,4100 | 1,0000 |
| Decay rate [1/d] | 0,0275 | 0,0275 | 1,0350 |
| Hydrogenotrophic max. spec. growth rate with SO4= [1/d] | 2,8000 | 2,8000 | 1,0350 |
| Hydrogenotrophic max. spec. growth rate with S [1/d] | 0,1000 | 0,1000 | 1,0350 |
| Hydrogen half sat. [mgCOD/L] | 0,0700 | 0,0700 | 1,0000 |
| Hydrogen sulfide inhibition coefficient [mgS/L] | 550,0000 | 550,0000 | 1,0000 |
| Sulfate (SO4=) half sat. [mgS/L] | 6,4100 | 6,4100 | 1,0000 |
| Sulfur (S) half sat. [mgS/L] | 50,0000 | 50,0000 | 1,0000 |
| Decay rate [1/d] | 0,0600 | 0,0600 | 1,0350 |

pH



| Name | Default | Value |
|--|---------|---------|
| Ordinary heterotrophic low pH limit [-] | 4,0000 | 4,0000 |
| Ordinary heterotrophic high pH limit [-] | 10,0000 | 10,0000 |
| Methylotrophic low pH limit [-] | 4,0000 | 4,0000 |
| Methylotrophic high pH limit [-] | 10,0000 | 10,0000 |
| Autotrophic low pH limit [-] | 5,5000 | 5,5000 |
| Autotrophic high pH limit [-] | 9,5000 | 9,5000 |
| Phosphorus accumulating low pH limit [-] | 4,0000 | 4,0000 |
| Phosphorus accumulating high pH limit [-] | 10,0000 | 10,0000 |
| Ordinary heterotrophic low pH limit (anaerobic) [-] | 5,5000 | 5,5000 |
| Ordinary heterotrophic high pH limit (anaerobic) [-] | 8,5000 | 8,5000 |
| Propionic acetogenic low pH limit [-] | 4,0000 | 4,0000 |
| Propionic acetogenic high pH limit [-] | 10,0000 | 10,0000 |
| Acetoclastic methanogenic low pH limit [-] | 5,0000 | 5,0000 |
| Acetoclastic methanogenic high pH limit [-] | 9,0000 | 9,0000 |
| H2-utilizing methanogenic low pH limit [-] | 5,0000 | 5,0000 |
| H2-utilizing methanogenic high pH limit [-] | 9,0000 | 9,0000 |

Switches

| Name | Default | Value |
|--|---------|--------|
| Ordinary heterotrophic DO half sat. [mgO2/L] | 0,1500 | 0,9000 |
| Phosphorus accumulating DO half sat. [mgO2/L] | 0,0500 | 0,1500 |
| Anoxic/anaerobic NOx half sat. [mgN/L] | 0,1500 | 0,1500 |
| Ammonia oxidizing DO half sat. [mgO2/L] | 0,2500 | 0,1000 |
| Nitrite oxidizing DO half sat. [mgO2/L] | 0,5000 | 0,5000 |
| Anaerobic ammonia oxidizing DO half sat. [mgO2/L] | 0,0100 | 0,0100 |
| Sulfur oxidizing sulfate pathway DO half sat. [mgO2/L] | 0,2500 | 0,2500 |
| Sulfur oxidizing sulfur pathway DO half sat. [mgO2/L] | 0,0500 | 0,0500 |



| | | |
|---|----------|----------|
| Anoxic NO ₃ (->NO ₂) half sat. [mgN/L] | 0,1000 | 0,1000 |
| Anoxic NO ₃ (->N ₂) half sat. [mgN/L] | 0,0500 | 0,0500 |
| Anoxic NO ₂ (->N ₂) half sat. (mgN/L) | 0,0100 | 0,0100 |
| NH ₃ nutrient half sat. [mgN/L] | 5,000E-3 | 5,000E-3 |
| PolyP half sat. [mgP/mgCOD] | 0,0100 | 0,0100 |
| VFA sequestration half sat. [mgCOD/L] | 5,0000 | 5,0000 |
| P uptake half sat. [mgP/L] | 0,1500 | 0,1500 |
| P nutrient half sat. [mgP/L] | 1,000E-3 | 1,000E-3 |
| Autotrophic CO ₂ half sat. [mmol/L] | 0,1000 | 0,1000 |
| H ₂ low/high half sat. [mgCOD/L] | 1,0000 | 1,0000 |
| Propionic acetogenic H ₂ inhibition [mgCOD/L] | 5,0000 | 5,0000 |
| Synthesis anion/cation half sat. [meq/L] | 0,0100 | 0,0100 |

Common

| Name | Default | Value |
|---|----------|----------|
| Biomass/Endog Ca content (gCa/gCOD) | 3,912E-3 | 3,912E-3 |
| Biomass/Endog Mg content (gMg/gCOD) | 3,912E-3 | 3,912E-3 |
| Biomass/Endog other cations content (mol/gCOD) | 5,115E-4 | 5,115E-4 |
| Biomass/Endog other Anions content (mol/gCOD) | 1,410E-4 | 1,410E-4 |
| N in endogenous residue [mgN/mgCOD] | 0,0700 | 0,0700 |
| P in endogenous residue [mgP/mgCOD] | 0,0220 | 0,0220 |
| Ca content of slowly biodegradabe (gCa/gCOD) | 3,912E-3 | 3,912E-3 |
| Mg content of slowly biodegradabe (gMg/gCOD) | 3,700E-4 | 3,700E-4 |
| Endogenous residue COD:VSS ratio [mgCOD/mgVSS] | 1,4200 | 1,4200 |
| Particulate substrate COD:VSS ratio [mgCOD/mgVSS] | 1,6327 | 1,4000 |
| Particulate inert COD:VSS ratio [mgCOD/mgVSS] | 1,6000 | 1,2000 |
| Cellulose COD:VSS ratio [mgCOD/mgVSS] | 1,4000 | 1,4000 |
| External organic COD:VSS ratio [mgCOD/mgVSS] | 1,6000 | 1,6000 |
| Molecular weight of other anions [mg/mmol] | 35,5000 | 35,5000 |



| | | |
|---|---------|---------|
| Molecular weight of other cations [mg/mmol] | 39,0983 | 39,0983 |
|---|---------|---------|

Ammonia oxidizing

| Name | Default | Value |
|------------------------------------|----------|----------|
| Yield [mgCOD/mgN] | 0,1500 | 0,1500 |
| Denite NO2 fraction as TEA [-] | 0,5000 | 0,5000 |
| Byproduct NH4 fraction to N2O [-] | 2,500E-3 | 2,500E-3 |
| N in biomass [mgN/mgCOD] | 0,0700 | 0,0700 |
| P in biomass [mgP/mgCOD] | 0,0220 | 0,0220 |
| Fraction to endogenous residue [-] | 0,0800 | 0,0800 |
| COD:VSS ratio [mgCOD/mgVSS] | 1,4200 | 1,4200 |

Nitrite oxidizing

| Name | Default | Value |
|------------------------------------|---------|--------|
| Yield [mgCOD/mgN] | 0,0900 | 0,0900 |
| N in biomass [mgN/mgCOD] | 0,0700 | 0,0700 |
| P in biomass [mgP/mgCOD] | 0,0220 | 0,0220 |
| Fraction to endogenous residue [-] | 0,0800 | 0,0800 |
| COD:VSS ratio [mgCOD/mgVSS] | 1,4200 | 1,4200 |

Anaerobic ammonia oxidizing

| Name | Default | Value |
|---------------------------------------|---------|--------|
| Yield [mgCOD/mgN] | 0,1140 | 0,1140 |
| Nitrate production [mgN/mgBiomassCOD] | 2,2800 | 2,2800 |
| N in biomass [mgN/mgCOD] | 0,0700 | 0,0700 |



| | | |
|------------------------------------|--------|--------|
| P in biomass [mgP/mgCOD] | 0,0220 | 0,0220 |
| Fraction to endogenous residue [-] | 0,0800 | 0,0800 |
| COD:VSS ratio [mgCOD/mgVSS] | 1,4200 | 1,4200 |

Ordinary heterotrophic

| Name | Default | Value |
|--|---------|--------|
| Yield (aerobic) [-] | 0,6660 | 0,6660 |
| Yield (fermentation, low H2) [-] | 0,1000 | 0,1000 |
| Yield (fermentation, high H2) [-] | 0,1000 | 0,1000 |
| H2 yield (fermentation low H2) [-] | 0,3500 | 0,3500 |
| H2 yield (fermentation high H2) [-] | 0 | 0 |
| Propionate yield (fermentation, low H2) [-] | 0 | 0 |
| Propionate yield (fermentation, high H2) [-] | 0,7000 | 0,7000 |
| CO2 yield (fermentation, low H2) [-] | 0,7000 | 0,7000 |
| CO2 yield (fermentation, high H2) [-] | 0 | 0 |
| N in biomass [mgN/mgCOD] | 0,0700 | 0,0700 |
| P in biomass [mgP/mgCOD] | 0,0220 | 0,0220 |
| Endogenous fraction - aerobic [-] | 0,0800 | 0,0800 |
| Endogenous fraction - anoxic [-] | 0,1030 | 0,1030 |
| Endogenous fraction - anaerobic [-] | 0,1840 | 0,1840 |
| COD:VSS ratio [mgCOD/mgVSS] | 1,4200 | 1,4200 |
| Yield (anoxic) [-] | 0,5400 | 0,5400 |
| Yield propionic (aerobic) [-] | 0,6400 | 0,6400 |
| Yield propionic (anoxic) [-] | 0,4600 | 0,4600 |
| Yield acetic (aerobic) [-] | 0,6000 | 0,6000 |
| Yield acetic (anoxic) [-] | 0,4300 | 0,4300 |
| Yield methanol (aerobic) [-] | 0,5000 | 0,5000 |
| Adsorp. max. [-] | 1,0000 | 1,0000 |
| Max fraction to N2O at high FNA over nitrate [-] | 0,0500 | 0,0500 |



| | | |
|---|--------|--------|
| Max fraction to N ₂ O at high FNA over nitrite [-] | 0,1000 | 0,1000 |
|---|--------|--------|

Ordinary heterotrophic on industrial COD

Methylotrophic

| Name | Default | Value |
|---|---------|--------|
| Yield (anoxic) [-] | 0,4000 | 0,4000 |
| N in biomass [mgN/mgCOD] | 0,0700 | 0,0700 |
| P in biomass [mgP/mgCOD] | 0,0220 | 0,0220 |
| Fraction to endogenous residue [-] | 0,0800 | 0,0800 |
| COD:VSS ratio [mgCOD/mgVSS] | 1,4200 | 1,4200 |
| Max fraction to N ₂ O at high FNA over nitrate [-] | 0,1000 | 0,1000 |
| Max fraction to N ₂ O at high FNA over nitrite [-] | 0,1500 | 0,1500 |

Phosphorus accumulating

| Name | Default | Value |
|--------------------------------------|---------|--------|
| Yield (aerobic) [-] | 0,6390 | 0,6390 |
| Yield (anoxic) [-] | 0,5200 | 0,5200 |
| Aerobic P/PHA uptake [mgP/mgCOD] | 0,9300 | 0,9300 |
| Anoxic P/PHA uptake [mgP/mgCOD] | 0,3500 | 0,6350 |
| Yield of PHA on Ac sequestration [-] | 0,8890 | 0,8890 |
| N in biomass [mgN/mgCOD] | 0,0700 | 0,0700 |
| N in sol. inert [mgN/mgCOD] | 0,0700 | 0,0700 |
| P in biomass [mgP/mgCOD] | 0,0220 | 0,0220 |
| Fraction to endogenous part. [-] | 0,2500 | 0,2500 |



| | | |
|---|--------|--------|
| Inert fraction of endogenous sol. [-] | 0,2000 | 0,2000 |
| P/Ac release ratio [mgP/mgCOD] | 0,5100 | 0,5300 |
| COD:VSS ratio [mgCOD/mgVSS] | 1,4200 | 1,4200 |
| Yield of low PP [-] | 0,9400 | 0,9400 |
| Mg to P mole ratio in polyphosphate [mmolMg/mmolP] | 0,3000 | 0,3000 |
| Cation to P mole ratio in polyphosphate [meq/mmolP] | 0,1500 | 0,1500 |
| Ca to P mole ratio in polyphosphate [mmolCa/mmolP] | 0,0500 | 0,0500 |

Propionic acetogenic

| Name | Default | Value |
|------------------------------------|---------|--------|
| Yield [-] | 0,1000 | 0,1000 |
| H2 yield [-] | 0,4000 | 0,4000 |
| CO2 yield [-] | 1,0000 | 1,0000 |
| N in biomass [mgN/mgCOD] | 0,0700 | 0,0700 |
| P in biomass [mgP/mgCOD] | 0,0220 | 0,0220 |
| Fraction to endogenous residue [-] | 0,0800 | 0,0800 |
| COD:VSS ratio [mgCOD/mgVSS] | 1,4200 | 1,4200 |

Methanogenic

| Name | Default | Value |
|---------------------------------------|---------|--------|
| Acetoclastic yield [-] | 0,1000 | 0,1000 |
| Acetoclastic yield on methanol[-] | 0,1000 | 0,1000 |
| H2-utilizing yield [-] | 0,1000 | 0,1000 |
| H2-utilizing yield on methanol [-] | 0,1000 | 0,1000 |
| N in acetoclastic biomass [mgN/mgCOD] | 0,0700 | 0,0700 |
| N in H2-utilizing biomass [mgN/mgCOD] | 0,0700 | 0,0700 |
| P in acetoclastic biomass [mgP/mgCOD] | 0,0220 | 0,0220 |



| | | |
|---|--------|--------|
| P in H2-utilizing biomass [mgP/mgCOD] | 0,0220 | 0,0220 |
| Acetoclastic fraction to endog. residue [-] | 0,0800 | 0,0800 |
| H2-utilizing fraction to endog. residue [-] | 0,0800 | 0,0800 |
| Acetoclastic COD:VSS ratio [mgCOD/mgVSS] | 1,4200 | 1,4200 |
| H2-utilizing COD:VSS ratio [mgCOD/mgVSS] | 1,4200 | 1,4200 |

Sulfur oxidizing

| Name | Default | Value |
|------------------------------------|---------|--------|
| Yield (aerobic) [mgCOD/mgS] | 0,5000 | 0,5000 |
| Yield (Anoxic) [mgCOD/mgS] | 0,3500 | 0,3500 |
| N in biomass [mgN/mgCOD] | 0,0700 | 0,0700 |
| P in biomass [mgP/mgCOD] | 0,0220 | 0,0220 |
| Fraction to endogenous residue [-] | 0,0800 | 0,0800 |
| COD:VSS ratio [mgCOD/mgVSS] | 1,4200 | 1,4200 |

Sulfur reducing

| Name | Default | Value |
|------------------------------------|---------|--------|
| Yield [mgCOD/mg H2 COD] | 0,0712 | 0,0712 |
| Yield [mgCOD/mg Ac COD] | 0,0470 | 0,0470 |
| Yield [mgCOD/mg Pr COD] | 0,0384 | 0,0384 |
| N in biomass [mgN/mgCOD] | 0,0700 | 0,0700 |
| P in biomass [mgP/mgCOD] | 0,0220 | 0,0220 |
| Fraction to endogenous residue [-] | 0,0800 | 0,0800 |
| COD:VSS ratio [mgCOD/mgVSS] | 1,4200 | 1,4200 |

General



| Name | Default | Value |
|--|----------|----------|
| Tank head loss per metre of length (from flow) [m/m] | 2,500E-3 | 2,500E-3 |
| BOD calculation rate constant for Xsc degradation [/d] | 0,5000 | 0,2800 |
| BOD calculation rate constant for Xsp (and hydrocarbon) degradation [/d] | 0,5000 | 0,2800 |
| BOD calculation rate constant for Xeo degradation [/d] | 0,5000 | 0,5000 |

Heating fuel/Chemical Costs

| Name | Default | Value |
|---|---------|--------|
| Methanol [€/L] | 0,3884 | 0,3884 |
| Ferric chloride [€/kg Fe] | 1,0327 | 1,0327 |
| Ferric sulfate [€/kg Fe] | 0,6973 | 0,6973 |
| Ferrous chloride [€/kg Fe] | 0,5384 | 0,5384 |
| Ferrous sulfate [€/kg Fe] | 2,0919 | 2,0919 |
| Aluminum sulfate [€/kg Al] | 1,4917 | 1,4917 |
| Aluminum chloride [€/kg Al] | 1,7477 | 1,7477 |
| Poly Aluminum Chloride (PAC) [€/kg Al] | 1,0327 | 1,0327 |
| Natural gas [€/GJ] | 2,6480 | 2,6480 |
| Heating oil [€/L] | 0,4413 | 0,4413 |
| Diesel [€/L] | 0,6179 | 0,6179 |
| Custom fuel [€/L] | 0,8827 | 0,8827 |
| Biogas sale price [€/GJ] | 1,7653 | 1,7653 |

Anaerobic digester

| Name | Default | Value |
|---|---------|---------|
| Bubble rise velocity (anaerobic digester) [cm/s] | 23,9000 | 23,9000 |
| Bubble Sauter mean diameter (anaerobic digester) [cm] | 0,3500 | 0,3500 |



| | | |
|--|--------|--------|
| Anaerobic digester gas hold-up factor [] | 1,0000 | 1,0000 |
|--|--------|--------|

Combined Heat and Power (CHP) engine

| Name | Default | Value |
|---------------------------------------|----------|----------|
| Methane heat of combustion [kJ/mole] | 800,0000 | 800,0000 |
| Hydrogen heat of combustion [kJ/mole] | 240,0000 | 240,0000 |
| CHP engine heat price [€/kWh] | 0 | 0 |
| CHP engine power price [€/kWh] | 0,1324 | 0,1324 |

Calorific values of heating fuels

| Name | Default | Value |
|---|---------|-------|
| Calorific value of natural gas [kJ/kg] | 48000 | 48000 |
| Calorific value of heating fuel oil [kJ/kg] | 42000 | 42000 |
| Calorific value of diesel [kJ/kg] | 46000 | 46000 |
| Calorific value of custom fuel [kJ/kg] | 32000 | 32000 |

Density of liquid heating fuels

| Name | Default | Value |
|-------------------------------------|---------|-------|
| Density of heating fuel oil [kg/m3] | 900 | 900 |
| Density of diesel [kg/m3] | 875 | 875 |
| Density of custom fuel [kg/m3] | 790 | 790 |

Mass transfer



| Name | Default | Value | |
|-------------------------|---------|---------|--------|
| KI for H2 [m/d] | 17,0000 | 17,0000 | 1,0240 |
| KI for CO2 [m/d] | 10,0000 | 10,0000 | 1,0240 |
| KI for NH3 [m/d] | 1,0000 | 1,0000 | 1,0240 |
| KI for CH4 [m/d] | 8,0000 | 8,0000 | 1,0240 |
| KI for N2 [m/d] | 15,0000 | 15,0000 | 1,0240 |
| KI for N2O [m/d] | 8,0000 | 8,0000 | 1,0240 |
| KI for H2S [m/d] | 1,0000 | 1,0000 | 1,0240 |
| KI for Ind #1 COD [m/d] | 0 | 0 | 1,0240 |
| KI for Ind #2 COD [m/d] | 0,5000 | 0,5000 | 1,0240 |
| KI for Ind #3 COD [m/d] | 0 | 0 | 1,0240 |
| KI for O2 [m/d] | 13,0000 | 13,0000 | 1,0240 |

Henry's law constants

| Name | Default | Value | |
|---------------|-----------|-----------|-----------|
| CO2 [M/atm] | 3,4000E-2 | 3,4000E-2 | 2400,0000 |
| O2 [M/atm] | 1,3000E-3 | 1,3000E-3 | 1500,0000 |
| N2 [M/atm] | 6,5000E-4 | 6,5000E-4 | 1300,0000 |
| N2O [M/atm] | 2,5000E-2 | 2,5000E-2 | 2600,0000 |
| NH3 [M/atm] | 5,8000E+1 | 5,8000E+1 | 4100,0000 |
| CH4 [M/atm] | 1,4000E-3 | 1,4000E-3 | 1600,0000 |
| H2 [M/atm] | 7,8000E-4 | 7,8000E-4 | 500,0000 |
| H2S [M/Atm] | 1,0000E-1 | 1,0000E-1 | 2200,0000 |
| Ind 1 [M/Atm] | 1,9000E+3 | 1,9000E+3 | 7300,0000 |
| Ind 2 [M/Atm] | 1,8000E-1 | 1,8000E-1 | 2200,0000 |
| Ind 3 [M/Atm] | 1,5000E-1 | 1,5000E-1 | 1900,0000 |

Properties constants



| Name | Default | Value |
|---|-----------|-----------|
| K in Viscosity = $K e^{-(E_a/RT)}$ [Pa s] | 6,849E-7 | 6,849E-7 |
| Ea in Viscosity = $K e^{-(E_a/RT)}$ [J/mol] | 1,780E+4 | 1,780E+4 |
| Y in ML Viscosity = H2O viscosity * (1+A*MLSS^Y) [-] | 1,0000 | 1,0000 |
| A in ML Viscosity = H2O viscosity * (1+A*MLSS^Y) [m3/g] | 1,000E-7 | 1,000E-7 |
| A in ML Density = H2O density + A*MLSS [(kg/m3)/(g/m3)] | 3,248E-4 | 3,248E-4 |
| A in Antoine equn. [T in K, P in Bar {NIST}] | 5,2000 | 5,2000 |
| B in Antoine equn. [T in K, P in Bar {NIST}] | 1734,0000 | 1734,0000 |
| C in Antoine equn. [T in K, P in Bar {NIST}] | -39,5000 | -39,5000 |

Metal salt solution densities

| Name | Default | Value |
|--|-----------|-----------|
| Ferric chloride solution density [kg/m3] | 3820,0000 | 3820,0000 |
| Ferric sulfate solution density [kg/m3] | 4800,0000 | 4800,0000 |
| Ferrous chloride solution density [kg/m3] | 3160,0000 | 3160,0000 |
| Ferrous sulfate solution density [kg/m3] | 1150,0000 | 1150,0000 |
| Aluminum sulfate solution density [kg/m3] | 1950,0000 | 1950,0000 |
| Aluminum chloride solution density [kg/m3] | 2480,0000 | 2480,0000 |

Mineral precipitation rates

| Name | Default | Value | |
|--|-----------|-----------|--------|
| Vivianite precipitation rate [L/(mol d)] | 1,000E+5 | 1,000E+5 | 1,0240 |
| Vivianite redissolution rate [L/(mol d)] | 1,000E+5 | 1,000E+5 | 1,0240 |
| Vivianite half sat. [mgTSS/L] | 0,0100 | 0,0100 | 1,0000 |
| FeS precipitation rate [L/(mol d)] | 1000,0000 | 1000,0000 | 1,0240 |
| FeS redissolution rate [L/(mol d)] | 10,0000 | 10,0000 | 1,0240 |



| | | | |
|--|------------|------------|--------|
| FeS half sat. [mgTSS/L] | 0,1000 | 0,1000 | 1,0000 |
| Struvite precipitation rate [L ² /(mol ² d)] | 3,000E+10 | 3,000E+10 | 1,0240 |
| Struvite redissolution rate [L ² /(mol ² d)] | 3,000E+11 | 3,000E+11 | 1,0240 |
| Struvite half sat. [mgTSS/L] | 1,0000 | 1,0000 | 1,0000 |
| Brushite precipitation rate [L/(mol d)] | 1,000E+6 | 1,000E+6 | 1,0000 |
| Brushite redissolution rate [L/(mol d)] | 10000,0000 | 10000,0000 | 1,0000 |
| Brushite half sat. [mgTSS/L] | 1,0000 | 1,0000 | 1,0000 |
| HAP precipitation rate [g/d] | 5,000E-4 | 5,000E-4 | 1,0000 |

Mineral precipitation constants

| Name | Default | Value |
|---|-----------|-----------|
| Vivianite solubility product [mol/L] ⁵ | 1,710E-36 | 1,710E-36 |
| FeS solubility product [mol/L] ² | 4,258E-4 | 4,258E-4 |
| Struvite solubility product [mol/L] ³ | 6,918E-14 | 6,918E-14 |
| Brushite solubility product [mol/L] ² | 2,490E-7 | 2,490E-7 |

Fe rates

| Name | Default | Value |
|---|-----------|------------------|
| A in aging rate = $A * \exp(-G/B)$ [1/d] | 16,1550 | 16,1550 1,0000 |
| B in aging rate = $A * \exp(-G/B)$ [1/s] | 57,3000 | 57,3000 1,0000 |
| HFO(L) aging rate factor | 2,500E-4 | 2,500E-4 1,0000 |
| HFO(H) with H ₂ PO ₄ ⁻ bound aging factor [] | 1,000E-5 | 1,000E-5 1,0000 |
| HFO(L) with H ₂ PO ₄ ⁻ bound aging factor [] | 0,4000 | 0,4000 1,0000 |
| H ₂ PO ₄ ⁻ coprecipitation rate [mol/(L d)] | 1,500E-9 | 1,500E-9 1,0000 |
| H ₂ PO ₄ ⁻ Adsorption rate [mol/(L d)] | 2,000E-11 | 2,000E-11 1,0000 |
| H ⁺ competition for HFO(H) protonation sites [L/(mmol . d)] | 1000,0000 | 1000,0000 1,0000 |
| H ⁺ competition for HFO(L) protonation sites [L/(mmol . d)] | 100,0000 | 100,0000 1,0000 |

Fe constants

| Name | Default | Value |
|---|------------|------------|
| Ferric active site factor(high) [{mol Sites}/{mol HFO(H)}] | 4,0000 | 4,0000 |
| Ferric active site factor(low) [{mol Sites}/{mol HFO(L)}] | 2,4000 | 2,4000 |
| H+ competition level for Fe(OH)3 [mol/L] | 7,000E-7 | 7,000E-7 |
| Equilibrium constant for FeOH3-H2PO4- [{mf HFO(H).H2PO4-}/({mol H2PO4-}{mf HFO(H)}^2)] | 2,000E-9 | 2,000E-9 |
| Colloidal COD removed with Ferric [gCOD/Fe active site] | 80,0000 | 80,0000 |
| Minimum residual P level with iron addition [mgP/L] | 0,0150 | 0,0150 |
| HFO(H) with H2PO4- P release factor | 10000,0000 | 10000,0000 |
| HFO(L) with H2PO4- P release factor | 10000,0000 | 10000,0000 |

Fe RedOx rates

| Name | Default | Value | |
|---|----------|----------|--------|
| Iron reduction using acetic acid | 1,000E-7 | 1,000E-7 | 1,0000 |
| Half Sat. acetic acid | 0,5000 | 0,5000 | 1,0000 |
| Iron reduction using propionic acid | 1,000E-7 | 1,000E-7 | 1,0000 |
| Half Sat. propionic acid | 0,5000 | 0,5000 | 1,0000 |
| Iron reduction using dissolved hydrogen gas | 1,000E-7 | 1,000E-7 | 1,0000 |
| Half Sat. dissolved hydrogen gas | 0,5000 | 0,5000 | 1,0000 |
| Iron reduction using hydrogen sulfide | 5,000E-5 | 5,000E-5 | 1,0000 |
| Half Sat. hydrogen sulfide | 0,5000 | 0,5000 | 1,0000 |
| Iron oxidation rate (aerobic) | 1,000E-3 | 1,000E-3 | 1,0000 |
| Abiotic iron reduction using acetic acid | 2,000E-5 | 2,000E-5 | 1,0000 |
| Abiotic iron reduction using propionic acid | 2,000E-5 | 2,000E-5 | 1,0000 |
| Abiotic iron reduction using dissolved hydrogen gas | 2,000E-5 | 2,000E-5 | 1,0000 |
| Abiotic iron reduction using hydrogen sulfide | 2,000E-5 | 2,000E-5 | 1,0000 |



| | | | |
|---------------------------------------|--------|--------|--------|
| Abiotic iron oxidation rate (aerobic) | 1,0000 | 1,0000 | 1,0000 |
|---------------------------------------|--------|--------|--------|

CEPT rates

| Name | Default | Value | |
|------------------------------------|---------|--------|--------|
| HFO colloidal adsorption rate | 1,0000 | 1,0000 | 1,0000 |
| Residual Xsc for adsorption to HFO | 5,0000 | 5,0000 | 1,0000 |
| Slope for Xsc residual | 1,0000 | 1,0000 | 1,0000 |
| HAO colloidal adsorption rate | 1,0000 | 1,0000 | 1,0000 |
| Residual Xsc for adsorption to HAO | 5,0000 | 5,0000 | 1,0000 |
| Slope for Xsc residual | 1,0000 | 1,0000 | 1,0000 |

AI rates

| Name | Default | Value | |
|---|----------|----------|--------|
| A in aging rate = $A * \exp(-G/B)$ [1/d] | 16,1550 | 16,1550 | 1,0000 |
| B in aging rate = $A * \exp(-G/B)$ [1/s] | 57,3000 | 57,3000 | 1,0000 |
| HAO(L) aging rate factor | 2,500E-4 | 2,500E-4 | 1,0000 |
| HAO(H) with H ₂ PO ₄ ⁻ bound aging factor [] | 1,000E-5 | 1,000E-5 | 1,0000 |
| HAO(L) with H ₂ PO ₄ ⁻ bound aging factor [] | 0,4000 | 0,4000 | 1,0000 |
| H ₂ PO ₄ ⁻ coprecipitation rate [mol/(L d)] | 1,500E-9 | 1,500E-9 | 1,0000 |
| H ₂ PO ₄ ⁻ Adsorption rate [mol/(L d)] | 1,000E-9 | 1,000E-9 | 1,0000 |

AI constants

| Name | Default | Value |
|---|---------|--------|
| AI active site factor(high) [{mol Sites}/{mol HAO(H)}] | 3,0000 | 3,0000 |
| AI active site factor(low) [{mol Sites}/{mol HAO(L)}] | 1,5000 | 1,5000 |



| | | |
|--|------------|------------|
| Equilibrium constant for $\text{AlOH}_3\text{-H}_2\text{PO}_4^-$ [$\frac{\text{mf HAO(H)} \cdot \text{H}_2\text{PO}_4^-}{(\text{mol H}_2\text{PO}_4^-) \cdot (\text{mf HAO(H)})^2}$] | 8,000E-10 | 8,000E-10 |
| Colloidal COD removed with Al [gCOD/Al active site] | 30,0000 | 30,0000 |
| Minimum residual P level with Al addition [mgP/L] | 0,0150 | 0,0150 |
| HAO(H) with H_2PO_4^- P release factor | 10000,0000 | 10000,0000 |
| HAO(L) with H_2PO_4^- P release factor | 10000,0000 | 10000,0000 |

Pipe and pump parameters

| Name | Default | Value |
|---|---------|---------|
| Static head [m] | 0,2500 | 0,2500 |
| Pipe length (headloss calc.s) [m] | 50,0000 | 50,0000 |
| Pipe inside diameter [mm] | 500,000 | 500,000 |
| K(fittings) - Total minor losses K | 5,0000 | 5,0000 |
| Pipe roughness [mm] | 0,200 | 0,200 |
| 'A' in overall pump efficiency = $A + B \cdot Q + C \cdot (Q^2)$ [-] | 0,8500 | 0,8500 |
| 'B' in overall pump efficiency = $A + B \cdot Q + C \cdot (Q^2)$ [-]/(m ³ /d)] | 0 | 0 |
| 'C' in overall pump efficiency = $A + B \cdot Q + C \cdot (Q^2)$ [-]/(m ³ /d) ²] | 0 | 0 |

Fittings and loss coefficients ('K' values)

| Name | Default | Value |
|---------------------------|---------|--------|
| Pipe entrance (bellmouth) | 0,0500 | 1,0000 |
| 90° bend | 0,7500 | 5,0000 |
| 45° bend | 0,3000 | 2,0000 |
| Butterfly valve (open) | 0,3000 | 1,0000 |
| Non-return valve | 1,0000 | 0 |
| Outlet (bellmouth) | 0,2000 | 1,0000 |



Aeration

| Name | Default | Value |
|---|----------|----------|
| Surface pressure [kPa] | 101,3250 | 101,3250 |
| Fractional effective saturation depth (Fed) [-] | 0,3250 | 0,3250 |
| Supply gas CO2 content [vol. %] | 0,0400 | 0,0400 |
| Supply gas O2 [vol. %] | 20,9500 | 20,9500 |
| Off-gas CO2 [vol. %] | 2,0000 | 2,0000 |
| Off-gas O2 [vol. %] | 18,8000 | 18,8000 |
| Off-gas H2 [vol. %] | 0 | 0 |
| Off-gas NH3 [vol. %] | 0 | 0 |
| Off-gas CH4 [vol. %] | 0 | 0 |
| Off-gas N2O [vol. %] | 0 | 0 |
| Surface turbulence factor [-] | 2,0000 | 2,0000 |
| Set point controller gain [] | 1,0000 | 1,0000 |

MABR Membrane effective diffusivities

| Name | Default | Value | |
|--------------|-----------|-----------|--------|
| O2 [m2/s] | 2,500E-9 | 2,500E-9 | 1,0000 |
| N2 [m2/s] | 1,900E-9 | 1,900E-9 | 1,0000 |
| CO2 [m2/s] | 1,960E-9 | 1,960E-9 | 1,0000 |
| H2 [m2/s] | 5,850E-9 | 5,850E-9 | 1,0000 |
| CH4 [m2/s] | 1,963E-9 | 1,963E-9 | 1,0000 |
| NH3 [m2/s] | 2,000E-9 | 2,000E-9 | 1,0000 |
| N2O [m2/s] | 1,607E-9 | 1,607E-9 | 1,0000 |
| H2S [m2/s] | 1,530E-9 | 1,530E-9 | 1,0000 |
| Ind 1 [m2/s] | 7,240E-10 | 7,240E-10 | 1,0000 |
| Ind 2 [m2/s] | 8,900E-10 | 8,900E-10 | 1,0000 |
| Ind 3 [m2/s] | 7,960E-10 | 7,960E-10 | 1,0000 |



MABR Membrane transfer factors

| Name | Default | Value | |
|----------|---------|--------|--------|
| O2 [] | 1,0000 | 1,0000 | 1,0000 |
| N2 [] | 1,0000 | 1,0000 | 1,0000 |
| CO2 [] | 1,0000 | 1,0000 | 1,0000 |
| H2 [] | 1,0000 | 1,0000 | 1,0000 |
| CH4 [] | 1,0000 | 1,0000 | 1,0000 |
| NH3 [] | 1,0000 | 1,0000 | 1,0000 |
| N2O [] | 1,0000 | 1,0000 | 1,0000 |
| H2S [] | 1,0000 | 1,0000 | 1,0000 |
| Ind 1 [] | 1,0000 | 1,0000 | 1,0000 |
| Ind 2 [] | 1,0000 | 1,0000 | 1,0000 |
| Ind 3 [] | 1,0000 | 1,0000 | 1,0000 |

Blower

| Name | Default | Value |
|--|---------|--------|
| Intake filter pressure drop [kPa] | 3,5000 | 3,5000 |
| Pressure drop through distribution system (piping/valves) [kPa] | 3,0000 | 3,0000 |
| Adiabatic/polytropic compression exponent (1.4 for adiabatic) | 1,4000 | 1,4000 |
| 'A' in blower efficiency = $A + B \cdot Q_a + C \cdot (Q_a^2) [-]$ | 0,7500 | 0,7500 |
| 'B' in blower efficiency = $A + B \cdot Q_a + C \cdot (Q_a^2) [\text{ - } / (\text{m}^3/\text{hr} (20\text{C}, 1 \text{ atm}))]$ | 0 | 0 |
| 'C' in blower efficiency = $A + B \cdot Q_a + C \cdot (Q_a^2) [\text{ - } / (\text{m}^3/\text{hr} (20\text{C}, 1 \text{ atm}))^2]$ | 0 | 0 |

Diffuser



| Name | Default | Value |
|---|---------|---------|
| k_1 in $C = k_1(PC)^{0.25} + k_2$ | 1,2400 | 1,2400 |
| k_2 in $C = k_1(PC)^{0.25} + k_2$ | 0,8960 | 0,8960 |
| Y in $Kla = C U_{sg} \cdot Y - U_{sg}$ in $[m^3/(m^2 d)]$ | 0,8880 | 0,8880 |
| Area of one diffuser $[m^2]$ | 0,0410 | 0,0380 |
| Diffuser mounting height $[m]$ | 0,2500 | 0,2500 |
| Min. air flow rate per diffuser m^3/hr (20C, 1 atm) | 0,5000 | 0,5000 |
| Max. air flow rate per diffuser m^3/hr (20C, 1 atm) | 10,0000 | 10,0000 |
| 'A' in diffuser pressure drop = $A + B \cdot (Qa/Diff) + C \cdot (Qa/Diff)^2$ $[kPa]$ | 3,0000 | 3,0000 |
| 'B' in diffuser pressure drop = $A + B \cdot (Qa/Diff) + C \cdot (Qa/Diff)^2$ $[kPa/(m^3/hr (20C, 1 atm))]$ | 0 | 0 |
| 'C' in diffuser pressure drop = $A + B \cdot (Qa/Diff) + C \cdot (Qa/Diff)^2$ $[kPa/(m^3/hr (20C, 1 atm))^2]$ | 0 | 0 |

Surface aerators

| Name | Default | Value |
|--|---------|---------|
| Surface aerator Std. oxygen transfer rate $[kg O / (kW hr)]$ | 1,50000 | 1,50000 |

Modified Vesilind

| Name | Default | Value |
|---|-----------|-----------|
| Maximum Vesilind settling velocity (V_0) $[m/d]$ | 170,000 | 170,000 |
| Vesilind hindered zone settling parameter (K) $[L/g]$ | 0,370 | 0,370 |
| Clarification switching function $[mg/L]$ | 100,000 | 100,000 |
| Specified TSS conc.for height calc. $[mg/L]$ | 2500,000 | 2500,000 |
| Maximum compactability constant $[mg/L]$ | 15000,000 | 15000,000 |
| Maximum compactability slope $[L/mg]$ | 0,010 | 0,010 |

Double exponential



| Name | Default | Value |
|---|-----------|-----------|
| Maximum Vesilind settling velocity (Vo) [m/d] | 410,000 | 410,000 |
| Maximum (practical) settling velocity (Vo') [m/d] | 270,000 | 270,000 |
| Hindered zone settling parameter (Kh) [L/g] | 0,400 | 0,400 |
| Flocculent zone settling parameter (Kf) [L/g] | 2,500 | 2,500 |
| Maximum non-settleable TSS [mg/L] | 20,0000 | 20,0000 |
| Non-settleable fraction [-] | 1,000E-3 | 1,000E-3 |
| Specified TSS conc. for height calc. [mg/L] | 2500,0000 | 2500,0000 |

Emission factors

| Name | Default | Value |
|---|----------|----------|
| Carbon dioxide equivalence of nitrous oxide | 296,0000 | 296,0000 |
| Carbon dioxide equivalence of methane | 23,0000 | 23,0000 |

Biofilm general

| Name | Default | Value | |
|---|-----------|-----------|--------|
| Attachment rate [g / (m2 d)] | 8,0000 | 8,0000 | 1,0000 |
| Attachment TSS half sat. [mg/L] | 100,0000 | 100,0000 | 1,0000 |
| Detachment rate [g/(m3 d)] | 8000,0000 | 8000,0000 | 1,0000 |
| Solids movement factor [] | 10,0000 | 10,0000 | 1,0000 |
| Diffusion neta [] | 0,8000 | 0,8000 | 1,0000 |
| Thin film limit [mm] | 0,5000 | 0,5000 | 1,0000 |
| Thick film limit [mm] | 3,0000 | 3,0000 | 1,0000 |
| Assumed Film thickness for tank volume correction (temp independent) [mm] | 1,2500 | 1,2500 | 1,0000 |
| Film surface area to media area ratio - Max.[] | 1,0000 | 1,0000 | 1,0000 |
| Minimum biofilm conc. for streamer formation [gTSS/m2] | 4,0000 | 4,0000 | 1,0000 |



Maximum biofilm concentrations [mg/L]

| Name | Default | Value | |
|--|-----------|-----------|--------|
| Biomass - Ordinary heterotrophic | 5,000E+4 | 5,000E+4 | 1,0000 |
| Biomass - Methylothetic | 5,000E+4 | 5,000E+4 | 1,0000 |
| Biomass - Ammonia oxidizing | 1,000E+5 | 1,000E+5 | 1,0000 |
| Biomass - Nitrite oxidizing | 1,000E+5 | 1,000E+5 | 1,0000 |
| Biomass - Anaerobic ammonia oxidizing | 5,000E+4 | 5,000E+4 | 1,0000 |
| Biomass - Phosphorus accumulating | 5,000E+4 | 5,000E+4 | 1,0000 |
| Biomass - Propionic acetogenic | 5,000E+4 | 5,000E+4 | 1,0000 |
| Biomass - Acetoclastic methanogenic | 5,000E+4 | 5,000E+4 | 1,0000 |
| Biomass - Hydrogenotrophic methanogenic | 5,000E+4 | 5,000E+4 | 1,0000 |
| Biomass - Endogenous products | 3,000E+4 | 3,000E+4 | 1,0000 |
| CODp - Slowly degradable particulate | 5000,0000 | 5000,0000 | 1,0000 |
| CODp - Slowly degradable colloidal | 4000,0000 | 4000,0000 | 1,0000 |
| CODp - Degradable external organics | 5000,0000 | 5000,0000 | 1,0000 |
| CODp - Undegradable non-cellulose | 5000,0000 | 5000,0000 | 1,0000 |
| CODp - Undegradable cellulose | 5000,0000 | 5000,0000 | 1,0000 |
| N - Particulate degradable organic | 0 | 0 | 1,0000 |
| P - Particulate degradable organic | 0 | 0 | 1,0000 |
| N - Particulate degradable external organics | 0 | 0 | 1,0000 |
| P - Particulate degradable external organics | 0 | 0 | 1,0000 |
| N - Particulate undegradable | 0 | 0 | 1,0000 |
| P - Particulate undegradable | 0 | 0 | 1,0000 |
| CODp - Stored PHA | 5000,0000 | 5000,0000 | 1,0000 |
| P - Releasable stored polyP | 1,150E+6 | 1,150E+6 | 1,0000 |
| P - Unreleasable stored polyP | 1,150E+6 | 1,150E+6 | 1,0000 |
| CODs - Complex readily degradable | 0 | 0 | 1,0000 |
| CODs - Acetate | 0 | 0 | 1,0000 |



| | | | |
|-------------------------------------|----------|----------|--------|
| CODs - Propionate | 0 | 0 | 1,0000 |
| CODs - Methanol | 0 | 0 | 1,0000 |
| Gas - Dissolved hydrogen | 0 | 0 | 1,0000 |
| Gas - Dissolved methane | 0 | 0 | 1,0000 |
| N - Ammonia | 0 | 0 | 1,0000 |
| N - Soluble degradable organic | 0 | 0 | 1,0000 |
| Gas - Dissolved nitrous oxide | 0 | 0 | 1,0000 |
| N - Nitrite | 0 | 0 | 1,0000 |
| N - Nitrate | 0 | 0 | 1,0000 |
| Gas - Dissolved nitrogen | 0 | 0 | 1,0000 |
| P - Soluble phosphate | 0 | 0 | 1,0000 |
| CODs - Undegradable | 0 | 0 | 1,0000 |
| N - Soluble undegradable organic | 0 | 0 | 1,0000 |
| Influent inorganic suspended solids | 1,300E+6 | 1,300E+6 | 1,0000 |
| Precipitate - Struvite | 8,500E+5 | 8,500E+5 | 1,0000 |
| Precipitate - Brushite | 1,165E+6 | 1,165E+6 | 1,0000 |
| Precipitate - Hydroxy - apatite | 1,600E+6 | 1,600E+6 | 1,0000 |
| Precipitate - Vivianite | 1,340E+6 | 1,340E+6 | 1,0000 |
| HFO - High surface | 5,000E+4 | 5,000E+4 | 1,0000 |
| HFO - Low surface | 5,000E+4 | 5,000E+4 | 1,0000 |
| HFO - High with H2PO4- adsorbed | 5,000E+4 | 5,000E+4 | 1,0000 |
| HFO - Low with H2PO4- adsorbed | 5,000E+4 | 5,000E+4 | 1,0000 |
| HFO - Aged | 5,000E+4 | 5,000E+4 | 1,0000 |
| HFO - Low with H+ adsorbed | 5,000E+4 | 5,000E+4 | 1,0000 |
| HFO - High with H+ adsorbed | 5,000E+4 | 5,000E+4 | 1,0000 |
| HAO - High surface | 5,000E+4 | 5,000E+4 | 1,0000 |
| HAO - Low surface | 5,000E+4 | 5,000E+4 | 1,0000 |
| HAO - High with H2PO4- adsorbed | 5,000E+4 | 5,000E+4 | 1,0000 |
| HAO - Low with H2PO4- adsorbed | 5,000E+4 | 5,000E+4 | 1,0000 |
| HAO - Aged | 5,000E+4 | 5,000E+4 | 1,0000 |
| P - Bound on aged HMO | 5,000E+4 | 5,000E+4 | 1,0000 |



| | | | |
|--|----------|----------|--------|
| Metal soluble - Magnesium | 0 | 0 | 1,0000 |
| Metal soluble - Calcium | 0 | 0 | 1,0000 |
| Metal soluble - Ferric | 0 | 0 | 1,0000 |
| Metal soluble - Ferrous | 0 | 0 | 1,0000 |
| Metal soluble - Aluminum | 0 | 0 | 1,0000 |
| Other Cations (strong bases) | 0 | 0 | 1,0000 |
| Other Anions (strong acids) | 0 | 0 | 1,0000 |
| Gas - Dissolved total CO2 | 0 | 0 | 1,0000 |
| User defined - UD1 | 0 | 0 | 1,0000 |
| User defined - UD2 | 0 | 0 | 1,0000 |
| User defined - UD3 | 5,000E+4 | 5,000E+4 | 1,0000 |
| User defined - UD4 | 5,000E+4 | 5,000E+4 | 1,0000 |
| Biomass - Sulfur oxidizing | 1,000E+5 | 1,000E+5 | 1,0000 |
| Biomass - Sulfur reducing propionic acetogenic | 5,000E+4 | 5,000E+4 | 1,0000 |
| Biomass - Sulfur reducing acetotrophic | 5,000E+4 | 5,000E+4 | 1,0000 |
| Biomass - Sulfur reducing hydrogenotrophic | 1,000E+5 | 1,000E+5 | 1,0000 |
| Gas - Dissolved total sulfides | 0 | 0 | 1,0000 |
| S - Soluble sulfate | 0 | 0 | 1,0000 |
| S - Particulate elemental sulfur | 5,000E+4 | 5,000E+4 | 1,0000 |
| Precipitate - Ferrous sulfide | 5,000E+4 | 5,000E+4 | 1,0000 |
| CODp - Adsorbed hydrocarbon | 5,000E+4 | 5,000E+4 | 1,0000 |
| CODs - Degradable volatile ind. #1 | 0 | 0 | 1,0000 |
| CODs - Degradable volatile ind. #2 | 0 | 0 | 1,0000 |
| CODs - Degradable volatile ind. #3 | 0 | 0 | 1,0000 |
| CODs - Soluble hydrocarbon | 0 | 0 | 1,0000 |
| Gas - Dissolved oxygen | 0 | 0 | 1,0000 |

Effective diffusivities [m²/s]

| Name | Default | Value |
|------|---------|-------|
|------|---------|-------|



| | | | |
|--|-----------|-----------|--------|
| Biomass - Ordinary heterotrophic | 5,000E-14 | 5,000E-14 | 1,0290 |
| Biomass - Methylothetic | 5,000E-14 | 5,000E-14 | 1,0290 |
| Biomass - Ammonia oxidizing | 5,000E-14 | 5,000E-14 | 1,0290 |
| Biomass - Nitrite oxidizing | 5,000E-14 | 5,000E-14 | 1,0290 |
| Biomass - Anaerobic ammonia oxidizing | 5,000E-14 | 5,000E-14 | 1,0290 |
| Biomass - Phosphorus accumulating | 5,000E-14 | 5,000E-14 | 1,0290 |
| Biomass - Propionic acetogenic | 5,000E-14 | 5,000E-14 | 1,0290 |
| Biomass - Acetoclastic methanogenic | 5,000E-14 | 5,000E-14 | 1,0290 |
| Biomass - Hydrogenotrophic methanogenic | 5,000E-14 | 5,000E-14 | 1,0290 |
| Biomass - Endogenous products | 5,000E-14 | 5,000E-14 | 1,0290 |
| CODp - Slowly degradable particulate | 5,000E-14 | 5,000E-14 | 1,0290 |
| CODp - Slowly degradable colloidal | 5,000E-10 | 5,000E-10 | 1,0290 |
| CODp - Degradable external organics | 5,000E-14 | 5,000E-14 | 1,0290 |
| CODp - Undegradable non-cellulose | 5,000E-14 | 5,000E-14 | 1,0290 |
| CODp - Undegradable cellulose | 5,000E-14 | 5,000E-14 | 1,0290 |
| N - Particulate degradable organic | 5,000E-14 | 5,000E-14 | 1,0290 |
| P - Particulate degradable organic | 5,000E-14 | 5,000E-14 | 1,0290 |
| N - Particulate degradable external organics | 5,000E-14 | 5,000E-14 | 1,0290 |
| P - Particulate degradable external organics | 5,000E-14 | 5,000E-14 | 1,0290 |
| N - Particulate undegradable | 5,000E-14 | 5,000E-14 | 1,0290 |
| P - Particulate undegradable | 5,000E-14 | 5,000E-14 | 1,0290 |
| CODp - Stored PHA | 5,000E-14 | 5,000E-14 | 1,0290 |
| P - Releasable stored polyP | 5,000E-14 | 5,000E-14 | 1,0290 |
| P - Unreleasable stored polyP | 5,000E-14 | 5,000E-14 | 1,0290 |
| CODs - Complex readily degradable | 6,900E-10 | 6,900E-10 | 1,0290 |
| CODs - Acetate | 1,240E-9 | 1,240E-9 | 1,0290 |
| CODs - Propionate | 8,300E-10 | 8,300E-10 | 1,0290 |
| CODs - Methanol | 1,600E-9 | 1,600E-9 | 1,0290 |
| Gas - Dissolved hydrogen | 5,850E-9 | 5,850E-9 | 1,0290 |
| Gas - Dissolved methane | 1,963E-9 | 1,963E-9 | 1,0290 |
| N - Ammonia | 2,000E-9 | 2,000E-9 | 1,0290 |



| | | | |
|---|-----------|-----------|--------|
| N - Soluble degradable organic | 1,370E-9 | 1,370E-9 | 1,0290 |
| Gas - Dissolved nitrous oxide | 1,607E-9 | 1,607E-9 | 1,0290 |
| N - Nitrite | 2,980E-9 | 2,980E-9 | 1,0290 |
| N - Nitrate | 2,980E-9 | 2,980E-9 | 1,0290 |
| Gas - Dissolved nitrogen | 1,900E-9 | 1,900E-9 | 1,0290 |
| P - Soluble phosphate | 2,000E-9 | 2,000E-9 | 1,0290 |
| CODs - Undegradable | 6,900E-10 | 6,900E-10 | 1,0290 |
| N - Soluble undegradable organic | 6,850E-10 | 6,850E-10 | 1,0290 |
| Influent inorganic suspended solids | 5,000E-14 | 5,000E-14 | 1,0290 |
| Precipitate - Struvite | 5,000E-14 | 5,000E-14 | 1,0290 |
| Precipitate - Brushite | 5,000E-14 | 5,000E-14 | 1,0290 |
| Precipitate - Hydroxy - apatite | 5,000E-14 | 5,000E-14 | 1,0290 |
| Precipitate - Vivianite | 5,000E-14 | 5,000E-14 | 1,0290 |
| HFO - High surface | 5,000E-14 | 5,000E-14 | 1,0290 |
| HFO - Low surface | 5,000E-14 | 5,000E-14 | 1,0290 |
| HFO - High with H ₂ PO ₄ - adsorbed | 5,000E-14 | 5,000E-14 | 1,0290 |
| HFO - Low with H ₂ PO ₄ - adsorbed | 5,000E-14 | 5,000E-14 | 1,0290 |
| HFO - Aged | 5,000E-14 | 5,000E-14 | 1,0290 |
| HFO - Low with H ⁺ adsorbed | 5,000E-14 | 5,000E-14 | 1,0290 |
| HFO - High with H ⁺ adsorbed | 5,000E-14 | 5,000E-14 | 1,0290 |
| HAO - High surface | 5,000E-14 | 5,000E-14 | 1,0290 |
| HAO - Low surface | 5,000E-14 | 5,000E-14 | 1,0290 |
| HAO - High with H ₂ PO ₄ - adsorbed | 5,000E-14 | 5,000E-14 | 1,0290 |
| HAO - Low with H ₂ PO ₄ - adsorbed | 5,000E-14 | 5,000E-14 | 1,0290 |
| HAO - Aged | 5,000E-14 | 5,000E-14 | 1,0290 |
| P - Bound on aged HMO | 5,000E-14 | 5,000E-14 | 1,0290 |
| Metal soluble - Magnesium | 7,200E-10 | 7,200E-10 | 1,0290 |
| Metal soluble - Calcium | 7,200E-10 | 7,200E-10 | 1,0290 |
| Metal soluble - Ferric | 4,800E-10 | 4,800E-10 | 1,0290 |
| Metal soluble - Ferrous | 4,800E-10 | 4,800E-10 | 1,0290 |
| Metal soluble - Aluminum | 4,800E-10 | 4,800E-10 | 1,0290 |



| | | | |
|--|-----------|-----------|--------|
| Other Cations (strong bases) | 1,440E-9 | 1,440E-9 | 1,0290 |
| Other Anions (strong acids) | 1,440E-9 | 1,440E-9 | 1,0290 |
| Gas - Dissolved total CO2 | 1,960E-9 | 1,960E-9 | 1,0290 |
| User defined - UD1 | 6,900E-10 | 6,900E-10 | 1,0290 |
| User defined - UD2 | 6,900E-10 | 6,900E-10 | 1,0290 |
| User defined - UD3 | 5,000E-14 | 5,000E-14 | 1,0290 |
| User defined - UD4 | 5,000E-14 | 5,000E-14 | 1,0290 |
| Biomass - Sulfur oxidizing | 5,000E-14 | 5,000E-14 | 1,0290 |
| Biomass - Sulfur reducing propionic acetogenic | 5,000E-14 | 5,000E-14 | 1,0290 |
| Biomass - Sulfur reducing acetotrophic | 5,000E-14 | 5,000E-14 | 1,0290 |
| Biomass - Sulfur reducing hydrogenotrophic | 5,000E-14 | 5,000E-14 | 1,0290 |
| Gas - Dissolved total sulfides | 1,530E-9 | 1,530E-9 | 1,0290 |
| S - Soluble sulfate | 2,130E-10 | 2,130E-10 | 1,0290 |
| S - Particulate elemental sulfur | 5,000E-14 | 5,000E-14 | 1,0290 |
| Precipitate - Ferrous sulfide | 5,000E-14 | 5,000E-14 | 1,0290 |
| CODp - Adsorbed hydrocarbon | 5,000E-14 | 5,000E-14 | 1,0290 |
| CODs - Degradable volatile ind. #1 | 7,240E-10 | 7,240E-10 | 1,0290 |
| CODs - Degradable volatile ind. #2 | 8,900E-10 | 8,900E-10 | 1,0290 |
| CODs - Degradable volatile ind. #3 | 7,960E-10 | 7,960E-10 | 1,0290 |
| CODs - Soluble hydrocarbon | 7,120E-10 | 7,120E-10 | 1,0290 |
| Gas - Dissolved oxygen | 2,500E-9 | 2,500E-9 | 1,0290 |

EPS Strength coefficients []

| Name | Default | Value | |
|---------------------------------------|---------|---------|--------|
| Biomass - Ordinary heterotrophic | 1,0000 | 1,0000 | 1,0000 |
| Biomass - Methyloctrophic | 1,0000 | 1,0000 | 1,0000 |
| Biomass - Ammonia oxidizing | 5,0000 | 5,0000 | 1,0000 |
| Biomass - Nitrite oxidizing | 25,0000 | 25,0000 | 1,0000 |
| Biomass - Anaerobic ammonia oxidizing | 10,0000 | 10,0000 | 1,0000 |



| | | | |
|--|--------|--------|--------|
| Biomass - Phosphorus accumulating | 1,0000 | 1,0000 | 1,0000 |
| Biomass - Propionic acetogenic | 1,0000 | 1,0000 | 1,0000 |
| Biomass - Acetoclastic methanogenic | 1,0000 | 1,0000 | 1,0000 |
| Biomass - Hydrogenotrophic methanogenic | 1,0000 | 1,0000 | 1,0000 |
| Biomass - Endogenous products | 1,0000 | 1,0000 | 1,0000 |
| CODp - Slowly degradable particulate | 1,0000 | 1,0000 | 1,0000 |
| CODp - Slowly degradable colloidal | 1,0000 | 1,0000 | 1,0000 |
| CODp - Degradable external organics | 1,0000 | 1,0000 | 1,0000 |
| CODp - Undegradable non-cellulose | 1,0000 | 1,0000 | 1,0000 |
| CODp - Undegradable cellulose | 1,0000 | 1,0000 | 1,0000 |
| N - Particulate degradable organic | 1,0000 | 1,0000 | 1,0000 |
| P - Particulate degradable organic | 1,0000 | 1,0000 | 1,0000 |
| N - Particulate degradable external organics | 1,0000 | 1,0000 | 1,0000 |
| P - Particulate degradable external organics | 1,0000 | 1,0000 | 1,0000 |
| N - Particulate undegradable | 1,0000 | 1,0000 | 1,0000 |
| P - Particulate undegradable | 1,0000 | 1,0000 | 1,0000 |
| CODp - Stored PHA | 1,0000 | 1,0000 | 1,0000 |
| P - Releasable stored polyP | 1,0000 | 1,0000 | 1,0000 |
| P - Unreleasable stored polyP | 1,0000 | 1,0000 | 1,0000 |
| CODs - Complex readily degradable | 0 | 0 | 1,0000 |
| CODs - Acetate | 0 | 0 | 1,0000 |
| CODs - Propionate | 0 | 0 | 1,0000 |
| CODs - Methanol | 0 | 0 | 1,0000 |
| Gas - Dissolved hydrogen | 0 | 0 | 1,0000 |
| Gas - Dissolved methane | 0 | 0 | 1,0000 |
| N - Ammonia | 0 | 0 | 1,0000 |
| N - Soluble degradable organic | 0 | 0 | 1,0000 |
| Gas - Dissolved nitrous oxide | 0 | 0 | 1,0000 |
| N - Nitrite | 0 | 0 | 1,0000 |
| N - Nitrate | 0 | 0 | 1,0000 |
| Gas - Dissolved nitrogen | 0 | 0 | 1,0000 |



| | | | |
|-------------------------------------|--------|--------|--------|
| P - Soluble phosphate | 0 | 0 | 1,0000 |
| CODs - Undegradable | 0 | 0 | 1,0000 |
| N - Soluble undegradable organic | 0 | 0 | 1,0000 |
| Influent inorganic suspended solids | 0,3300 | 0,3300 | 1,0000 |
| Precipitate - Struvite | 1,0000 | 1,0000 | 1,0000 |
| Precipitate - Brushite | 1,0000 | 1,0000 | 1,0000 |
| Precipitate - Hydroxy - apatite | 1,0000 | 1,0000 | 1,0000 |
| Precipitate - Vivianite | 1,0000 | 1,0000 | 1,0000 |
| HFO - High surface | 1,0000 | 1,0000 | 1,0000 |
| HFO - Low surface | 1,0000 | 1,0000 | 1,0000 |
| HFO - High with H2PO4- adsorbed | 1,0000 | 1,0000 | 1,0000 |
| HFO - Low with H2PO4- adsorbed | 1,0000 | 1,0000 | 1,0000 |
| HFO - Aged | 1,0000 | 1,0000 | 1,0000 |
| HFO - Low with H+ adsorbed | 1,0000 | 1,0000 | 1,0000 |
| HFO - High with H+ adsorbed | 1,0000 | 1,0000 | 1,0000 |
| HAO - High surface | 1,0000 | 1,0000 | 1,0000 |
| HAO - Low surface | 1,0000 | 1,0000 | 1,0000 |
| HAO - High with H2PO4- adsorbed | 1,0000 | 1,0000 | 1,0000 |
| HAO - Low with H2PO4- adsorbed | 1,0000 | 1,0000 | 1,0000 |
| HAO - Aged | 1,0000 | 1,0000 | 1,0000 |
| P - Bound on aged HMO | 1,0000 | 1,0000 | 1,0000 |
| Metal soluble - Magnesium | 0 | 0 | 1,0000 |
| Metal soluble - Calcium | 0 | 0 | 1,0000 |
| Metal soluble - Ferric | 0 | 0 | 1,0000 |
| Metal soluble - Ferrous | 0 | 0 | 1,0000 |
| Metal soluble - Aluminum | 0 | 0 | 1,0000 |
| Other Cations (strong bases) | 0 | 0 | 1,0000 |
| Other Anions (strong acids) | 0 | 0 | 1,0000 |
| Gas - Dissolved total CO2 | 0 | 0 | 1,0000 |
| User defined - UD1 | 0 | 0 | 1,0000 |
| User defined - UD2 | 0 | 0 | 1,0000 |



| | | | |
|--|--------|--------|--------|
| User defined - UD3 | 1,0000 | 1,0000 | 1,0000 |
| User defined - UD4 | 1,0000 | 1,0000 | 1,0000 |
| Biomass - Sulfur oxidizing | 1,0000 | 1,0000 | 1,0000 |
| Biomass - Sulfur reducing propionic acetogenic | 1,0000 | 1,0000 | 1,0000 |
| Biomass - Sulfur reducing acetotrophic | 1,0000 | 1,0000 | 1,0000 |
| Biomass - Sulfur reducing hydrogenotrophic | 1,0000 | 1,0000 | 1,0000 |
| Gas - Dissolved total sulfides | 0 | 0 | 1,0000 |
| S - Soluble sulfate | 0 | 0 | 1,0000 |
| S - Particulate elemental sulfur | 1,0000 | 1,0000 | 1,0000 |
| Precipitate - Ferrous sulfide | 1,0000 | 1,0000 | 1,0000 |
| CODp - Adsorbed hydrocarbon | 1,0000 | 1,0000 | 1,0000 |
| CODs - Degradable volatile ind. #1 | 0 | 0 | 1,0000 |
| CODs - Degradable volatile ind. #2 | 0 | 0 | 1,0000 |
| CODs - Degradable volatile ind. #3 | 0 | 0 | 1,0000 |
| CODs - Soluble hydrocarbon | 0 | 0 | 1,0000 |
| Gas - Dissolved oxygen | 0 | 0 | 1,0000 |

